



EDUCATIONAL

01

EDUCATIONAL





## EDUCATIONAL "Desk System - PRO"

01



Cassetto a scomparsa per notebook o monitor, tastiera e mouse / *Disappearing drawer for notebook monitor, keyboard and mouse*





Sistema completo di scrivania,  
angolo di raccordo e tavolo laterale

*System complete with desk,  
side table and 90° angle*



DESK80180 con DESK17  
DESK80180 with DESK17

Serratura del cassetto a scomparsa  
*Lock of the disappearing drawer*



Passaggio cablaggi nella struttura metallica  
*Cables passage through the metal frame*



Piano scrivania stondato  
*Desk top is rounded*



Ingresso cavi alla base dei quattro piedi  
*Cable entry at the base of four feet*



DESK17 Supporto porta PC regolabile  
*DESK17 adjustable holder for PC*





## EDUCATIONAL "Desk System - PRO"

107

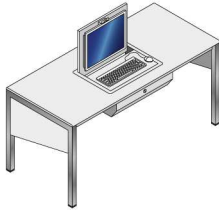
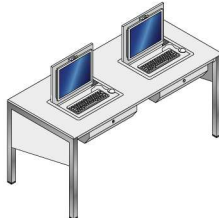
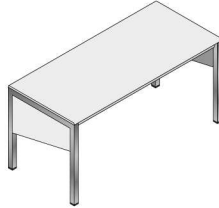
	<p><b>DESK80180</b></p> <p><b>Componenti / Components</b></p> <p>DESKGN180F</p> <p>DESKGN80L_DX</p> <p>DESKGN80L_SX</p> <p>DESK18080PIAF624487</p> <p>DESK800PIE1</p> <p>DESKNET5834</p> <p>DESKTRAV180</p>	<p>Scrivania 80x180 con meccanismo porta notebook / tastiera / monitor - modello pro <i>Desk 80x180 with disappearing drawer for laptop / keyboard / monitor - model pro</i></p> <p>nr 1 Gonna frontale 180 <i>Frontal Skirt</i></p> <p>nr 1 Gonna destra <i>Right skirt</i></p> <p>nr 1 Gonna sinistra <i>Left skirt</i></p> <p>nr 1 Piano tavolo 80x180 cm con foro per desknet5384 <i>80x180 cm desk table top with hole for desknet5384</i></p> <p>nr 2 Gamba desk <i>Leg desk</i></p> <p>nr 1 Cassetto a scomparsa con meccanismo + top + attacco vesa regolabile <i>Disappearing drawer + top + vesa adjustable mount</i></p> <p>nr 2 Traversa/passacavo 180 <i>Cross beam cable trunking 180</i></p>
	<p><b>DESK801802</b></p> <p><b>Componenti / Components</b></p> <p>DESKGN180F</p> <p>DESKGN80L_DX</p> <p>DESKGN80L_SX</p> <p>DESK18080PIA2F624487</p> <p>DESK800PIE1</p> <p>DESKNET5834</p> <p>DESKTRAV180</p>	<p>Scrivania 80x180 con 2 cassetti a scomparsa per notebook / tastiera / monitor - modello pro <i>Desk 80x180 with 2 disappearing drawers for laptop / keyboard / monitor - model pro</i></p> <p>nr 1 Gonna frontale 180 <i>Frontal Skirt</i></p> <p>nr 1 Gonna destra <i>Right skirt</i></p> <p>nr 1 Gonna sinistra <i>Left skirt</i></p> <p>nr 1 Piano tavolo 80x180 cm con 2 fori per desknet5384 <i>Table top 80x180</i></p> <p>nr 2 Gamba desk <i>Leg desk</i></p> <p>nr 2 Cassetto a scomparsa con meccanismo + top + attacco vesa regolabile <i>Disappearing drawer + top + vesa adjustable mount</i></p> <p>nr 2 Traversa/passacavo 180 <i>Cross beam cable trunking</i></p>
	<p><b>DESK80180S</b></p> <p><b>Componenti / Components</b></p> <p>DESKGN180F</p> <p>DESKGN80L_DX</p> <p>DESKGN80L_SX</p> <p>DESK18080PIA</p> <p>DESK800PIE1</p> <p>DESKTRAV180</p>	<p>Scrivania 180x80 senza cassetto a scomparsa - modello pro <i>Desk 180x80 without disappearing drawer - model pro</i></p> <p>nr 1 Gonna frontale <i>Frontal Skirt</i></p> <p>nr 1 Gonna destra <i>Right skirt</i></p> <p>nr 1 Gonna sinistra <i>Left skirt</i></p> <p>nr 1 Piano tavolo 180x180 <i>Desk 80x100</i></p> <p>nr 2 Gamba desk <i>Leg desk</i></p> <p>nr 2 Traversa/passacavo 180 <i>Cross beam cable trunking 180</i></p>



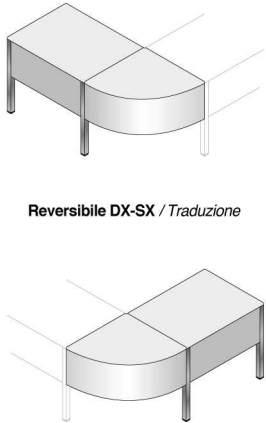
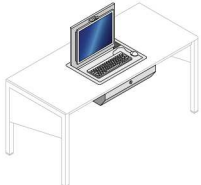
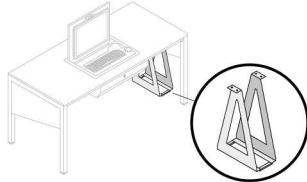
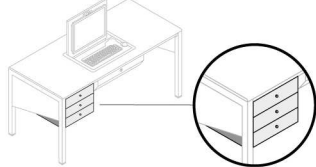

	<p><b>DESK80100</b></p> <p><b>Componenti / Components</b></p> <p>DESK800PIE1</p> <p>DESK10080PIA</p> <p>DESKGN80L_DX</p> <p>DESKGN80L_SX</p> <p>DESKTRAV100</p> <p>DESKGN100F</p>	<p>Scrivania 100x80 senza cassetto a scomparsa - modello pro <i>Desk 100x80 without disappearing drawer - model pro</i></p> <p>nr 2 Gamba desk <i>Leg desk</i></p> <p>nr 1 Piano tavolo 80x100 <i>Desk 80x100</i></p> <p>nr 1 Gonna destra <i>Right skirt</i></p> <p>nr 1 Gonna sinistra <i>Right skirt</i></p> <p>nr 2 Traversa passacavo 100 <i>Cross beam cable trunking 100</i></p> <p>nr 1 Gonna frontale 100 <i>Frontal Skirt</i></p>
 <p>Reversibile DX-SX / Traduzione</p>	<p><b>DESKA90D80100</b></p> <p><b>Componenti / Components</b></p> <p>DESK800PIE2</p> <p>DESK8080A90PIA</p> <p>DESK10080PIA</p> <p>DESKGN8080A90F</p> <p>DESKTRAV100</p> <p>DESKTRAV8080A90</p> <p>DESKGN100F</p>	<p>Curva + desk 80x100 - modello pro <i>Angle 90° + 80x100 desk - model pro</i></p> <p>nr 2 Piede doppio per giuntare angolo con scrivania <i>Foot for splicing double desk corner</i></p> <p>nr 1 Piano tavolo/curva 80x80 <i>Table top / angle 90° 80x80</i></p> <p>nr 1 Piano tavolo 80x100 <i>desk 80x100</i></p> <p>nr 1 Gonna frontale in lamiera verniciata per angolo 90° <i>Frontal skirt for 90° angle</i></p> <p>nr 2 Traversa passacavo 100 <i>Cross beam cable trunking 100</i></p> <p>nr 1 Traversa passacavo per curva <i>Cross cable for angle 90°</i></p> <p>nr 1 Gonna frontale 100 <i>Frontal Skirt 100</i></p>
	<p><b>DESKNET5834</b></p>	<p>Cassetto a scomparsa + top + attacco vesa regolabile <i>Disappearing drawer + top + vesa adjustable support</i></p>
	<p><b>DESKTW17</b></p>	<p>Supporto per computer desktop regolabile in larghezza <i>Support for desktop computers with adjustable width</i></p>
	<p><b>DESK3CC</b></p>	<p>Cassettiera 3 cassetti per DESK80180 <i>3 drawers for DESK80180</i></p>





## EDUCATIONAL "Desk System - PRO"

Esempi di composizioni / *Composition examples*

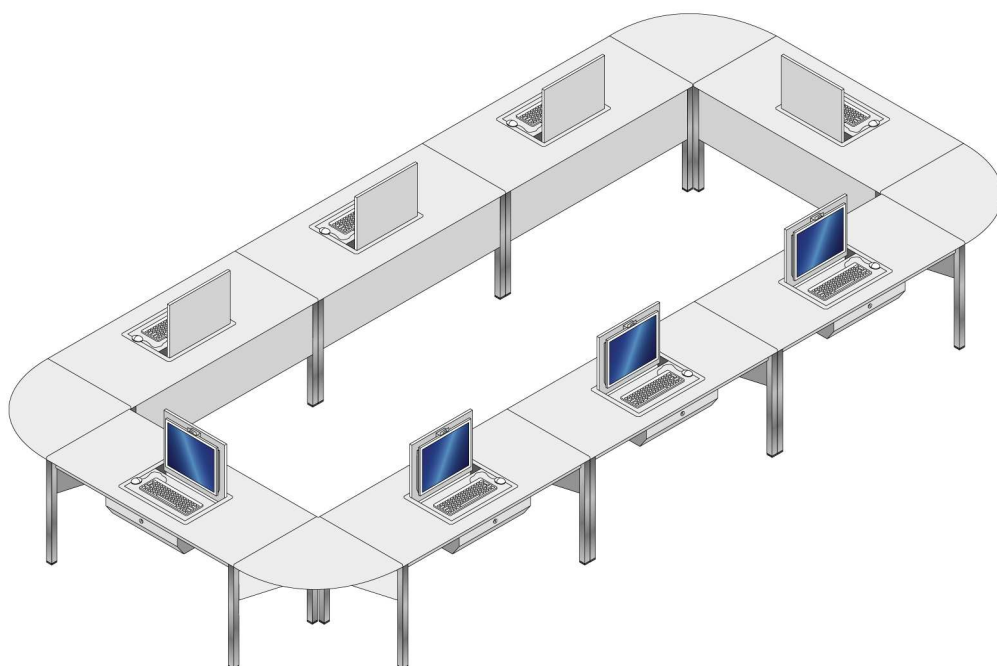
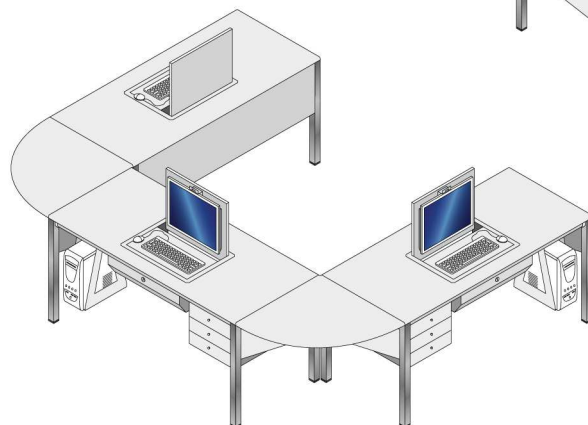
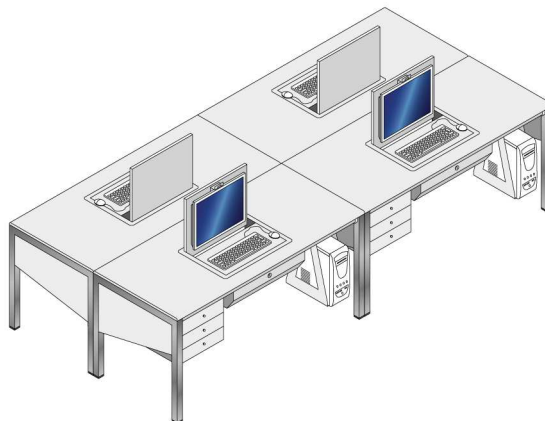
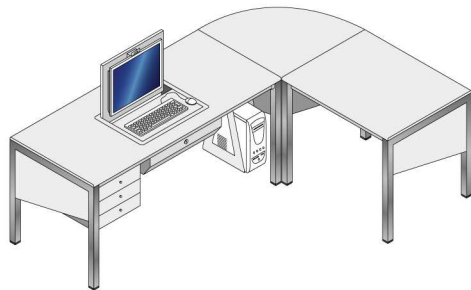

01



Esempi di composizioni / *Composition examples*

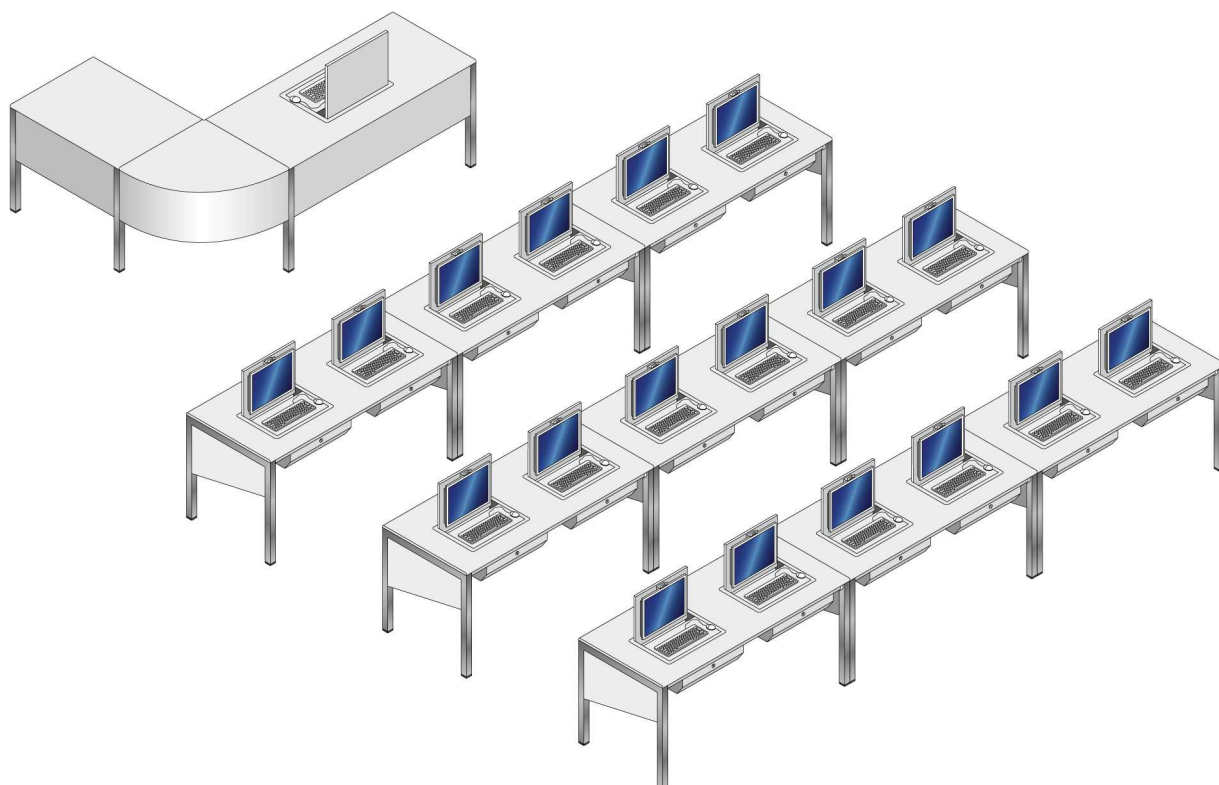
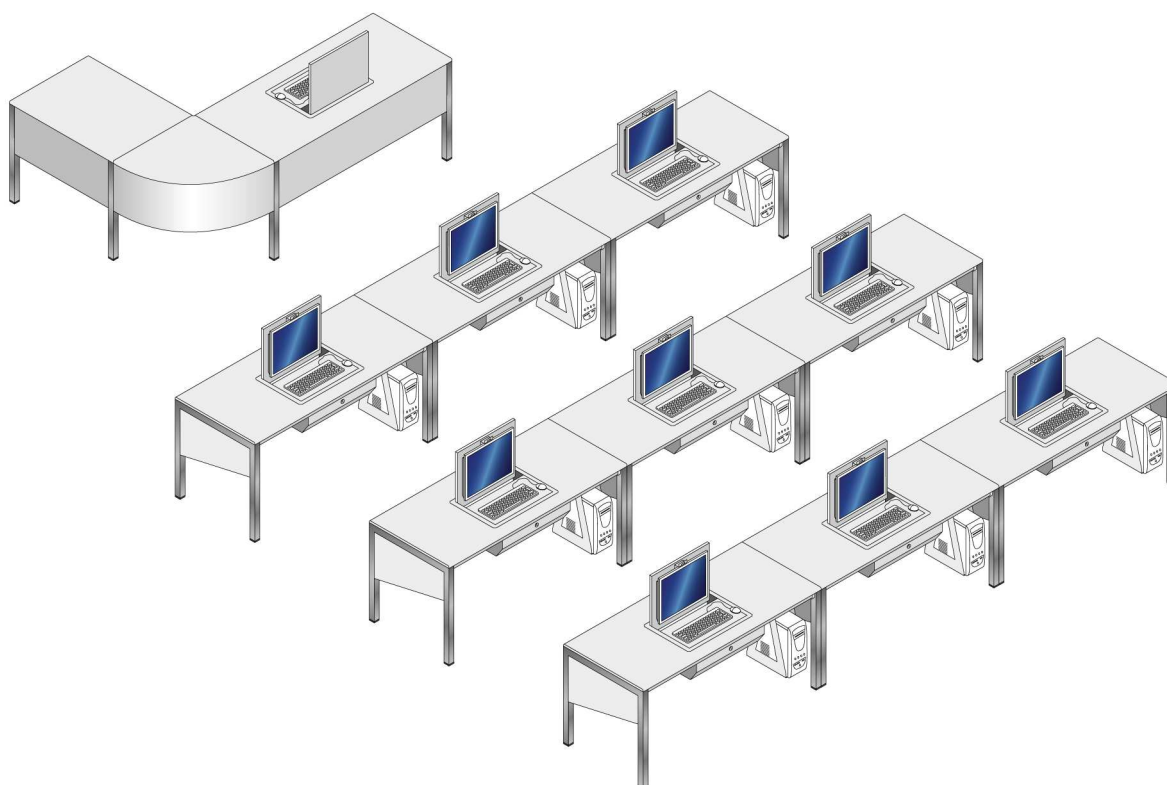



## EDUCATIONAL "Desk System - BASIC"

**SCRIVANIA DOCENTE BASIC-LINE CON CASSETTO A SCOMPARSA**  
**TEACHER DESK WITH DISAPPEARING DRAWER BASIC-LINE**

Gambe sormontate da distanziali per un facile attraversamento dei cavi da una postazione all'altra .

Piani in melaminico, spessore mm. 25, colore grigio e bordi perimetrali in profilo di abs arrotondato.

Struttura pannellata in melaminico, grigio, spessore mm.18 per la traversa e spessore mm.25 per i fianchi, completi di piedini di livellamento e distanziali di collegamento al piano in pvc rigido colore argento, bordi perimetrali in profilo di abs arrotondato.

Meccanismo a scomparsa dotato di pistoncini a gas e serratura di sicurezza , per l'alloggiamento di computer portatile o tastiera + schermo + mouse

Verniciatura epossidica antigraffio delle parti metalliche

*Legs surmounted by spacers for easy crossing of cables from one location to another.*

*Melamine tops, mm. 25 and Edges in rounded abs.*

*Panel structure of melamine, gray, crossbar thickness 18 mm and sides thickness 25 mm Complete with leveling feet and spacers connection to the surface rigid PVC silver Edges in rounded abs.*

*Retractable mechanism equipped with gas pistons and security lock, for accommodating laptop or screen , keyboard and mouse*

*Scratch resistant epoxy coating of metal parts*

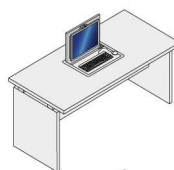

Vista laterale

**DESK80180NEW1**

Scrivania 80x180 con meccanismo a scomparsa porta notebook / tastiera / monitor , modello basic

*Desk 80x180 with 1 disappearing drawer for laptop / keyboard / monitor - model basic*

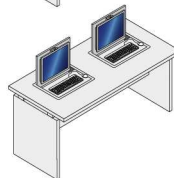
**DESK80180NEW2**

Scrivania 80x180 con 2 meccanismi a scomparsa porta notebook / tastiera / monitor , modello basic

*Desk 80x180 with 2 disappearing drawers for laptop / keyboard / monitor - model basic*

**DESK80160NEW1**

Scrivania 80x160 con meccanismo a scomparsa porta notebook / tastiera / monitor , modello basic

*Desk 80x160 with 1 disappearing drawer for laptop / keyboard / monitor - model basic*

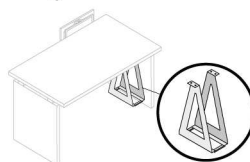
**DESK80160NEW1**

Supporto per computer desktop regolabile in larghezza

*Support for desktop computers with adjustable width*



## Art. SPLAV100E

**SUPPORTO UNIVERSALE INTEGRATO PER LAVAGNE INTERATTIVE - MOTORIZZATO**  
**UNIVERSAL MOTORIZED INTEGRATED SUPPORT FOR INTERACTIVE BOARDS AND SCREENS**

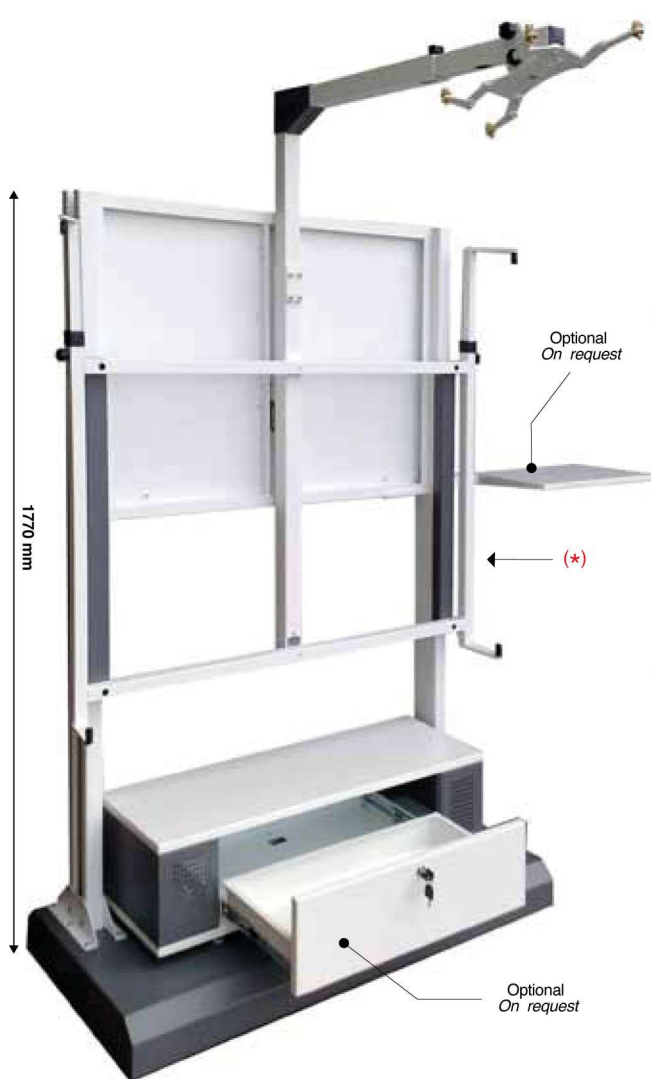

Progettato per le LIM di qualsiasi marca, che abbiano dimensioni da 830 a 1460 mm. di altezza, con sistema di fissaggio adatto agli spessori da 1 a 100 mm. Il carrello integra anche un supporto universale per videoproiettori a corta e cortissima focale che può essere ruotato fino a 90°, in caso si renda necessario uno spostamento del sistema da un ambiente ad un altro. Presenta inoltre un sistema che permette, in caso necessari, di abbassare agevolmente il braccio porta V.P. fino a toccare la sommità della lavagna.

E' possibile modificare a piacimento l'altezza da terra della lavagna/schermo: min 487 mm. / max 987 mm. Il tutto avviene mediante motore elettrico azionato dall'utente con interruttore sali/scendi presente sulla struttura del supporto.

La solida base nasconde 4 ruote di grande portata per un agevole spostamento.

- (\*) Sul lato del supporto è presente una scatola con 3 prese universali per l'alimentazione dei componenti montati sul carrello; questo permette di alimentare il sistema con un unico cavo (incluso). Il passaggio dei cavi avviene tutto all'interno della struttura. Verniciato con polveri epossidiche.

*Projected for IWB of any brand, with dimension from 830 to 1430 mm height, securing system suitable for depth from 1 to 100 mm.*

*The support is also integrated with an universal short/very short throw video-projector support, which can be turned 90° and totally lowered in case the system needs to be moved from one place to another.*

*It is possible to modify the height of the board/screen between 487 to 987 mm from the floor. Everything controlled by an electric motor activated by an up/down switch integrated in support structure.*

*The sturdy base hides 4 casters of generous dimensions, for an easy moving.*

- (\*) On one side you find power supply box with 3 universal sockets; this box can provide power to the system using a single cable (included). Cable passage is totally internal to the support. Epoxy painted.

### La versione in foto presenta (optional):

- **SPLAV100MB** un utile ripiano porta computer che può essere montato alla dx o alla sx della lavagna e può essere adattato a tutte le larghezze possibili
- **SPLAV100RP** un contenitore metallico, con cassettoni integrati dotato di chiusura a chiave, con frontali microforati per eventuale posizionamento di diffusori audio
- **SPLAV100CV** Ulteriore optional, non visibile nella foto, è una prolunga per il comando motore.

### Version in picture features (on request):

- **SPLAV100RP** a useful shelf for holding a laptop, mountable both to the right or the left of the board and adaptable to any possible board width;
- **SPLAV100MB** a metal box with integrated extractable drawer, with lock and key, micro-predrilled at the front for positioning audio speaker cabinets.
- **SPLAV100CV** Further optional (not in picture) is an extension cable for the motor engine.



Front view



Side view

#### Max Load / Portata:

70 Kg

#### Tech Info:

73,6 Kg

1 pz

0,4521 cbm

#### Colours:

Bianco-Grigio  
White-Grey



## EDUCATIONAL

01

### Art. SPLAV100E

#### SCHEDA TECNICA

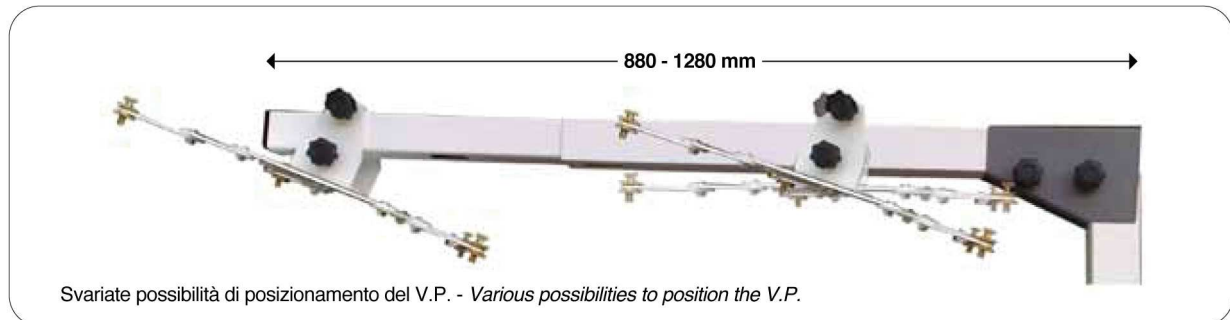

Svariate possibilità di posizionamento del V.P. - *Various possibilities to position the V.P.*

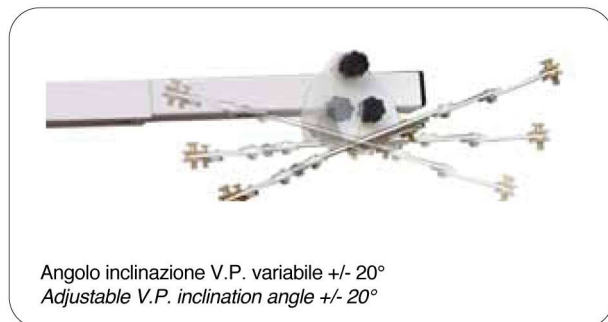

Angolo inclinazione V.P. variabile +/- 20°  
*Adjustable V.P. inclination angle +/- 20°*



Sistema "easy" di sganciamento per girare il braccio porta V.P.  
*"Easy Detachment" System to turn the V.P. support arm.*



Ragno universale con viteria in ottone per fissaggio "fine" del V.P.. Possibilità di fissaggio decentrato del V.P. (+/- 70 mm). Passaggio di cavi e connettori all'interno.

*Universal V.P. holder, include screw kit for fine regulation Possibility to mount the V.P. offset (+/- 70 mm). Cable and connectors run inside the structure*

Capiente l'armadietto, con chiusura a chiave e guide ad estrazione totale, capace di contenere al suo interno anche un Notebook, ed eventualmente, due diffusori acustici protetti con chiusura a chiave. Predisposto con foro per ingresso cavi. Optional.

*Wide and capacious locker, with luides for total extraction and key. You can store a notebook inside as well as two audio enclosures, protected by the keylock. Prefitted with cable receptacle. On request.*

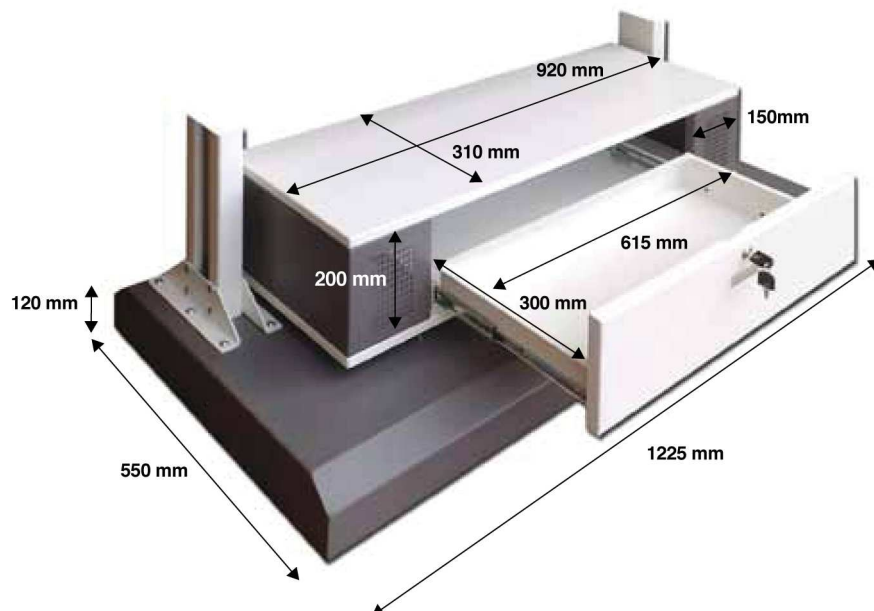

## Art. SPLAV100PRT

**SUPPORTO UNIVERSALE INTEGRATO A PARETE PER LAVAGNE INTERATTIVE MOTORIZZATO CON APPOGGIO A TERRA**  
**UNIVERSAL MOTORIZED INTEGRATED WALL SUPPORT FOR INTERACTIVE BOARDS AND SCREENS WITH GROUND SUPPORT**



<b>Max Load / Portata:</b>	
	70 Kg

<b>Tech Info:</b>	
	50 Kg
	1 pz
	1,0415 cbm

<b>Colours:</b>	
	
Bianco-Grigio White-Grey	

Progettato per le LIM di qualsiasi marca, che abbiano dimensioni da 830 a 1460 mm. di altezza, con sistema di fissaggio adatto agli spessori da 1 a 100 mm.

Il carrello integra anche un supporto universale per videoproiettori a corta e cortissima focale che può essere ruotato di 90°.

E' possibile modificare a piacimento l'altezza da terra della lavagna/schermo: min 487 mm. / max 987 mm. Il tutto avviene mediante motore elettrico azionato dall'utente con interruttore sali/scendi presente sulla struttura del supporto.

(\*) Sul retro del supporto è presente una scatola con 3 prese universali per l'alimentazione dei componenti montati sul carrello; questo permette di alimentare il sistema con un unico cavo (incluso).

Il passaggio dei cavi avviene tutto all'interno della struttura. Le basi di appoggio a terra sono portanti, pertanto, in caso necessari, possono essere idoneamente fissate a terra sopportando da sole il peso della struttura.

Verniciato con polveri epossidiche.

*Projected for IWB of any brand, with dimension from 830 to 1430 mm height, securing system suitable for depth from 1 to 100 mm.*

*The support is also integrated with an universal short/very short throw video-projector support, which can be turned 90°.*

*It is possible to modify the height of the board/screen between 487 to 987 mm from the floor.*

*Everything controlled by an electric motor activated by an up/down switch integrated in support structure.*

(\*) *On one side you find power supply box with 3 universal sockets; this box can provide power to the system using a single cable (included). Cable passage is totally internal to the support.*

*The ground bases can support alone, if needs, the weight of the structure if correctly fastened to the ground.*

*Epoxy painted.*







EDUCATIONAL

**Art. SPLAV50PRT**

**SUPPORTO UNIVERSALE PER LIM INTEGRATO, FISSO, A PARETE, PER LAVAGNE INTERATTIVE CON APPOGGIO A TERRA**  
**UNIVERSAL INTEGRATED FIXED WALL SUPPORT FOR INTERACTIVE BOARDS AND SCREENS WITH GROUND SUPPORT**



Max Load / Portata:	
	80 Kg

Tech Info:	
	33 Kg
	1 pz
	0,2312 cbm

Colours:	
	Bianco-Grigio White-Grey

Optional / On request:  
**SPLAV100MB-PRT**



Versione mobile con SPLAV-BRG  
 (non incluso - vedi pag. 22)  
 Mobile version with SPLAV-BRG  
 (not included - see page 22)

Progettato per le LIM di qualsiasi marca, che abbiano dimensioni da 830 a 1460 mm. di altezza, con sistema di fissaggio adatto agli spessori da 1 a 100 mm.

Il carrello integra anche un supporto universale per videoproiettori a corta e cortissima focale che può essere ruotato di 90°.

E' possibile installare la lavagna a piacimento ad un'altezza da terra: min 487 mm. / max 987 mm. Verniciato con polveri epossidiche.

Le basi di appoggio a terra sono portanti, pertanto, in caso necessiti, possono essere idoneamente fissate a terra sopportando da sole il peso della struttura.

Verniciato con polveri epossidiche.

Projected for IWB of any brand, with dimension from 830 to 1430 mm height, securing system suitable for depth from 1 to 100 mm.

The support is also integrated with an universal short/very short throw video-projector support, which can be turned 90°.

It is possible to install the whiteboard at the desired height between 487 to 987 mm from the floor.

The ground bases can support alone, if needs, the weight of the structure if correctly fastened to the ground. Epoxy painted.



## Art. SPLAV60PRT

SUPPORTO UNIVERSALE PER LIM INTEGRATO A PARETE, CON APPOGGIO A TERRA, PER LAVAGNE INTERATTIVE, CON REGOLAZIONE IN ALTEZZA MECCANICA, A SFORZO ZERO.  
UNIVERSAL INTEGRATED ADJUSTABLE WALL SUPPORT FOR INTERACTIVE BOARDS AND SCREENS WITH GROUND SUPPORT AND MECHANICAL HEIGHT ADJUSTMENT, WITH "ZERO" EFFORT.

### Colours:



### Tech Info:

	50 Kg
	1 pz
	1,140 cbm

### Max Load / Portata:

	70 Kg
--	-------

Versione mobile con SPLAV-BRG  
(non incluso - vedi pag. 22)  
Mobile version with SPLAV-BRG  
(not included - see page 22)

## Art. SPLAV60PRT-P

1 kg di contrappeso / 1 kg balance block



Formula per calcolare il peso da inserire:

$$\text{PESO LIM} + \text{PESO PROIETTORE} - 8 \text{ KG} = \text{PESO DA INSERIRE}$$

$$\text{WEIGHT IWB} + \text{WEIGHT PROJECTOR} - 8 \text{ KG} = \text{WEIGHT TO BALANCE}$$

Progettato per le LIM di qualsiasi marca, che abbiano dimensioni da 830 a 1460 mm. di altezza, con sistema di fissaggio adatto agli spessori da 1 a 100 mm.

Il carrello integra anche un supporto universale per videoproiettori a corta e cortissima focale che può essere ruotato di 90°.

E' possibile modificare a piacimento l'altezza da terra della lavagna/schermo: min 487 mm. / max 987 mm. Il tutto avviene manualmente con sistema di ausilio meccanico che rende lo sforzo di salita e discesa prossimo allo Zero.

Le basi di appoggio a terra sono portanti, pertanto, in caso necessiti, possono essere idoneamente fissate a terra sopportando da sole il peso della struttura.

Verniciato con polveri epossidiche.

Projected for IWB of any brand, with dimension from 830 to 1430 mm height, securing system suitable for depth from 1 to 100 mm.

The support is also integrated with an universal short/very short throw video-projector support, which can be turned 90°.

It is possible to modify the height of the board/screen between 487 to 987 mm from the floor with a mechanical device that permit the adjustment without any effort.

The ground bases can support alone, if needs, the weight of the structure if correctly fastened to the ground.

Epoxy painted.





# EDUCATIONAL

# 01

## SPLAV-BRG

Descrizione  
Description

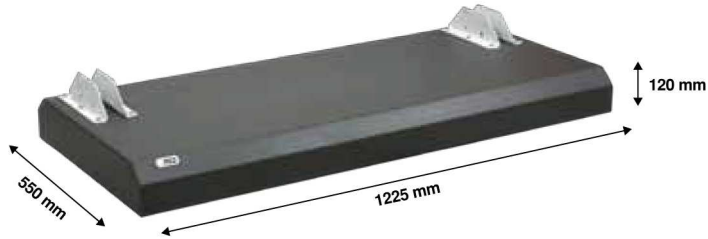

Base mobile completa di adattatori per SPLAV50PRT e SPALV60PRT

Mobile base with adapters for SPLAV50PRT, SPALV60PRT

Tech Info:	
	24 Kg
	1 pz
	0,2606 cbm

Colours:	
Bianco White	Grigio Grey

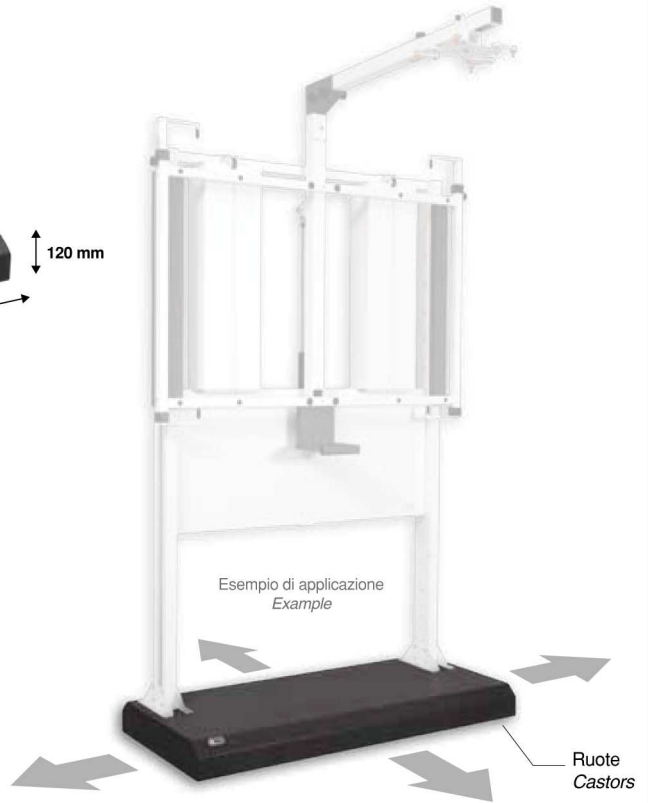

## SPLAV\_STS

ADATTATORE PER MONTARE TV DI GROSSE DIMENSIONI SU TUTTI I SUPPORTI LIM MD SERIE SPLAV

ADAPTER THAT PERMIT TO MOUNT BIG TV ON ALL MD IWB MOUNTS SPLAV SERIES

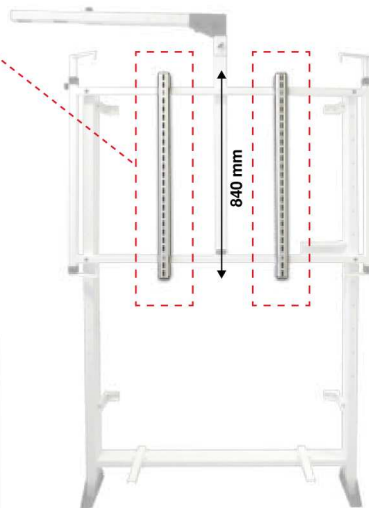

Esempio di applicazione  
Example

Tech Info:	
	2,3 Kg
	1 pz
	0,0078 cbm

## SPLAV100CV

PROLUNGA PER IL COMANDO MOTORE PER SPLAV100E, SPLAV100PRT

EXTENSION CABLE FOR THE MOTOR ENGINE CONTROL FOR SPLAV100E, SPLAV100PRT



## NETBOXVVT

**KIT VENTOLE + TERMOSTATO**  
KIT FANS + THERMOSTAT



Kit composto da 2 ventole 8x8x3,8 cm + termostato.  
Per **NETBOX518** e **NETBOX526**.

*Kit 2 fans 8x8x3,8 cm + thermostat.*  
*For NETBOX518 and NETBOX526.*



## SPLAV100MB

**ARMADIETTO CON CASSETTO ESTRAIBILE**  
LOCKER WITH EXTRACTABLE DRAWER

Colours:

Bianco White Grigio Grey



Tech Info:	
	16 Kg
	1 pz
	0,0893 cbm

Armadietto in lamiera, verniciata con polveri epossidiche, con cassetto estraibile dotato di serratura e chiave. Presenta alle 2 estremità frontali una griglia forata utile per il posizionamento all'interno di diffusori audio.  
Per **SPLAV100E**.

*Epoxy Painted metal locker, with extractable drawer and key-lock.*  
*Front is pre-drilled for positioning speaker cabinets inside.*  
*For SPLAV100E.*

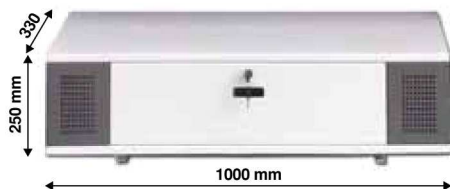

## SPLAV100MB-PRT

**ARMADIETTO CON CASSETTO ESTRAIBILE + ADATTATORE PER SUPPORTI A PARETE SERIE PRT**  
LOCKER WITH EXTRACTABLE DRAWER + ADAPTER FOR WALL LIM MOUNTS PRT SERIES



Per **SPLAV50PRT**, **SPLAV60PRT** e **SPLAV100PRT**

For **SPLAV50PRT**, **SPLAV60PRT** e **SPLAV100PRT**

Tech Info:	
	19 Kg
	1 pz
	0,0893 cbm



## SPLAV100RP

**RIPIANO PER COMPUTER PORTATILE**  
LAPTOP SHELF



Ripiano di appoggio per computer portatile, dim. 470x300 mm, realizzato in lamiera, verniciata con polveri epossidiche, posizionabile su entrambi i lati e adattabile alla larghezza della lavagna.  
Per **SPLAV100E**.

*Epoxy painted metal shelf for positioning a laptop. Mountable on both right or left side of the structure, totally adaptable to the width of the board.*  
*For SPLAV100PRT.*



Tech Info:	
	4,2 Kg
	1 pz
	0,0190 cbm

## SPLAV100RP-PRT

**RIPIANO PER COMPUTER PORTATILE + ADATTATORE PER SUPPORTI A PARETE PRT SERIES**  
LAPTOP SHELF WITH + ADAPTER FOR WALL IWB MOUNTS PRT SERIES



Per **SPLAV50PRT** e **SPLAV100PRT**  
For **SPLAV50PRT** e **SPLAV100PRT**

Tech Info:	
	4,8 Kg
	1 pz
	0,0190 cbm





## EDUCATIONAL

**Art. SNB100****BOX DI SICUREZZA DA PARETE PER NOTEBOOK FINO A 19" CON RIBALTINA E SCOMPARTO INFERIORE APRIBILE DALL'INTERNO.****SECURITY WALL BOX FOR NOTEBOOK UP TO 19" WITH FLAP AND LOWER BIN THAT CAN BE OPENED ONLY FROM THE INSIDE**

Un utilissimo supporto/armadietto per mettere in sicurezza, fissato a parete, un notebook e tutti i suoi accessori. Utilissimo posizionato al fianco di lavagne interattive multimediali come piano di appoggio/vano per il notebook che gestisce il sistema LIM oppure come semplice contenitore di sicurezza per chiudere i notebook quando sono in carica. Grazie alla sua robusta struttura in acciaio ed alla serratura di sicurezza, garantisce la massima sicurezza in dimensioni particolarmente contenute. La dimensione del piano permette l'utilizzo di notebook fino a 19" lasciando anche una parte del piano utile per utilizzo di un mouse esterno o di una tavoletta grafica; permette inoltre di lasciare fissati i vari cavi (rgb, USB, etc) anche quando viene richiuso.

Il vano inferiore, apribile solo dall'interno, con la ribaltina abbassata, a 1/2 di comodi pomellini, è utile per posizionare l'alimentatore e altri cavi. Ribaltina 37x60 cm con doppia cerniera a frizione tarabile e asole per il passaggio di strisce di velcro (incluse) utili per il fissaggio del notebook al piano.

Chiusura con chiave di sicurezza tubolare

*An useful stand / cabinet to secure, fixed to the wall, a notebook and all its accessories.*

*Useful positioned alongside multimedia interactive whiteboards as a shelf /*

*compartment for your notebook that manages the IWB system or as a simple security container to close the notebook in*

*office.*

*Thanks to its sturdy steel frame and safety lock, guarantees maximum safety in very compact size. The size of the plan allows the use of laptops up to 19" allowing even a useful part of the plan to use an external mouse or a graphics tablet and allows to leave attached to the cables (RGB, USB, etc.) even when is closed. The lower compartment can be opened only from within, with the flap down, easily by 2 knobs, it is useful to place the power adapter and other cables. 37x60 cm flap with double adjustable friction hinge and slot for the passage of Velcro strips (included) that are useful for securing the notebook to the floor*

Realizzato in acciaio verniciato a forno con polveri epossidiche

**Dimensioni:** 60Hx66Lx13P cm

Peso: 18 Kg

Made of steel epoxy painted



**Dimensions:** cm 60Hx66Wx13D

Weight: 18 Kg

**Colours:**

Bianco / White

**Tech Info:**

 18 Kg
 1 pz
 0,0696 cbm





**Art. SNB50**
**BOX DI SICUREZZA DA PARETE PER NOTEBOOK FINO A 19" CON RIBALTINA**  
*SECURITY WALL BOX FOR NOTEBOOK UP TO 19" WITH FLAP*

Un utilissimo supporto/armadietto per mettere in sicurezza, fissato a parete, un notebook e tutti i suoi accessori. Utilissimo posizionato al fianco di lavagne interattive multimediali come piano di appoggio/vano per il notebook che gestisce il sistema LIM oppure come semplice contenitore di sicurezza per chiudere i notebook quando sono in carica. Grazie alla sua robusta struttura in acciaio ed alla serratura di sicurezza, garantisce la massima sicurezza in dimensioni particolarmente contenute. La dimensione del piano permette l'utilizzo di notebook fino a 19" lasciando anche una parte del piano utile per utilizzo di un mouse esterno o di una tavoletta grafica; permette inoltre di lasciare fissati i vari cavi (rgb, USB, etc) anche quando viene chiuso.

Ribaltina 37x60 cm con doppia cerniera a frizione tarabile e aseole per il passaggio di strisce di velcro (incluse) utili per il fissaggio del notebook al piano.

Chiusura con chiave di sicurezza tubolare

*An useful stand / cabinet to secure, fixed to the wall, a notebook and all its accessories.*

*Useful positioned alongside multimedia interactive whiteboards as a shelf/compartment for your notebook that*

*manages the IWB system or as a simple security container to close the notebook when in office.*



*Thanks to its sturdy steel frame and safety lock, guarantees maximum safety in very compact size. The size of the plan allows the use of laptops up to 19" allowing even a useful part of the plan to use an external mouse or a graphics tablet and allows to leave attached to the cables (RGB, USB, etc.) even when is closed. 37x60 cm flap with double adjustable friction hinge and slot for the passage of Velcro strips (included) that are useful for securing the notebook to the floor.*

Realizzato in acciaio verniciato a forno con polveri epossidiche

**Dimensioni:** 50Hx66Lx13P cm

*Made of steel epoxy painted*

**Dimensions:** cm 50Hx66Wx13D

Colours:	Tech Info:
Bianco / White	
	 1 pz
	 0,053 cbm

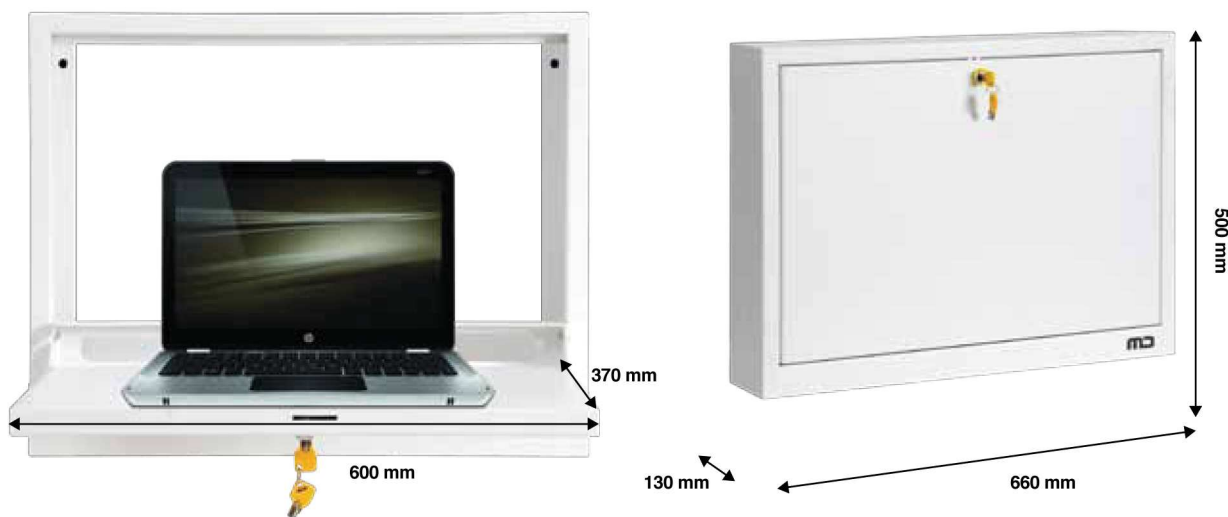



EDUCATIONAL

**Art. BPC484517P****BOX PER PC CON CHIAVE DI SICUREZZA PER FISSAGGIO A PARETE**  
WALL MOUNTING PERSONAL COMPUTER BOX WITH SAFETY LOCK

Box per PC con chiave di sicurezza per fissaggio a parete. Utile per posizionare al lato di una LIM, a parete, o sotto una scrivania, fissandolo alle pannellature laterali, un PC di medie dimensioni con tastiera e mouse. Realizzato con lamiera d'acciaio da 10/10. Verniciato con polveri epossidiche.

## Dimensioni esterne

H 450 mm

L 170 mm

P 480 mm

## Dimensioni utili interne

H 448 mm

L 165 mm

P 470 mm

Box PC with security key for wall mounting. Useful for positioning the side of a LIM, wall or under a desk, starting at the side panels, a medium-sized PC with keyboard and mouse..

Made from sheet steel 10/10.

Epoxy painted.

## External dimensions

H 450 mm

L 170 mm

P 480 mm

## Helpful internal dimensions

H 448 mm

L 165 mm

P 470 mm

## Art. STEDU2P104

ARMADIO DI SICUREZZA A RIPIANI MOBILI SU RUOTE  
SECURITY UNIT WITH MOBILE SHELVES WITH CASTORS



Armadio su 4 ruote, chiuso su 3 lati, con porta frontale a 2 ante con serratura di sicurezza a doppia espansione e 3 ripiani mobili.

E' possibile montare fino a 11 ripiani mod.

STEDU2P104-RPW

Realizzato con lamiera d'acciaio da 10/10.

Verniciato con polveri epossidiche.

### Dimensioni esterne

H 730 mm

P 400 mm

L 660 mm

### Ripiani interni

L 600 mm

P 365 mm

Cabinet on 4 castors, closed on three sides, with 2 shutters and security lock with double expansion.

It is possible to mount up to 11 shelves Mod.

STEDU2P104-RPW .

Made from sheet steel 10/10.

Epoxy painted.

### External dimensions

H 730 mm

P 400 mm

L 660 mm

### Internal shelves

L 600 mm

P 365 mm

## Art. STEDU2P104-RPW

RIPIANO MOBILE PER STEDU2P104  
MOBILE SHELVES FOR STEDU2P104

Ripiano mobile per STEDU2P104

Realizzato con lamiera d'acciaio da 10/10.

Verniciato con polveri epossidiche.

### Dimensioni utili

L 600 mm

P 365 mm

Master pack: 2 pezzi

Mobile shelve for STEDU2P104.

Made from sheet steel 10/10.

Epoxy painted.

### Useful dimensions

L 600 mm

P 365 mm

Master pack: 2 pcs





EDUCATIONAL

01



A large, rounded rectangular area containing horizontal lines for writing. The lines are evenly spaced and extend across the width of the page. A single, thicker horizontal line is positioned approximately one-third of the way down the page, serving as a section separator.



## Art. DESKNETEX1U

Cassetto in acciaio per notebook protetto da serratura a chiave tubolare. Può essere fissato sotto qualunque scrivania indifferentemente sul lato dx o sx. Dotato di sistema esclusivo per sollevare il notebook per permettere l'utilizzo del lettore cd/dvd e di un sistema di sicurezza che evita la chiusura accidentale del cassetto. Verniciato con polveri epossidiche. Dimensioni esterne 44x8x56 cm. Può alloggiare comodamente notebook da oltre 17" (profondità max 32 cm spessore 4 cm)

*Steel drawer for notebook protected with tubular key lock. It can be fixed under any desk either on the right or left side. Featuring exclusive system to lift your notebook to allow the use of CD / DVD player and a safety system that prevents accidental closing of the drawer. Coated with epoxy. External dimensions 44x8x56 cms. Can easily accommodate notebooks over 17" ( max 32 cm depth, 4 cm thickness).*



Cassetto interamente estraibile su guide in acciaio. Draw fully removable on steel guides.

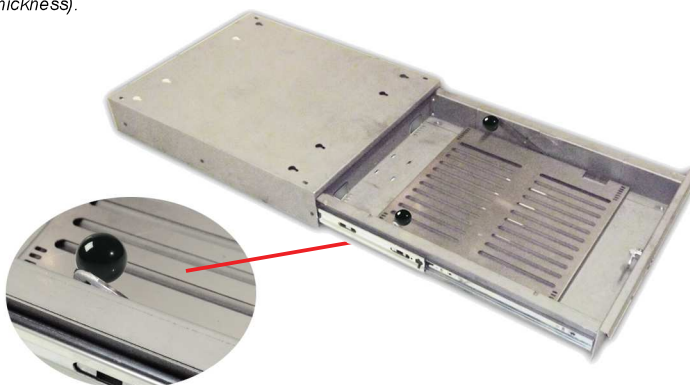

Base del notebook in acciaio, aerata, sollevabile agendo su semplice meccanismo. Una volta sollevata la base del notebook il cassetto non può richiudersi accidentalmente grazie ad un doppio blocco meccanico. Base of the notebook is made of steel, ventilated, lifted by acting on simple mechanism. Once you have raised the base of the notebook can not close the drawer by accident thanks to a double mechanical lock.

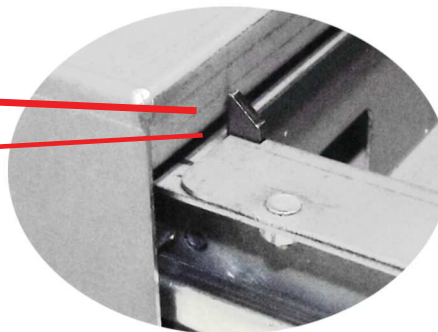
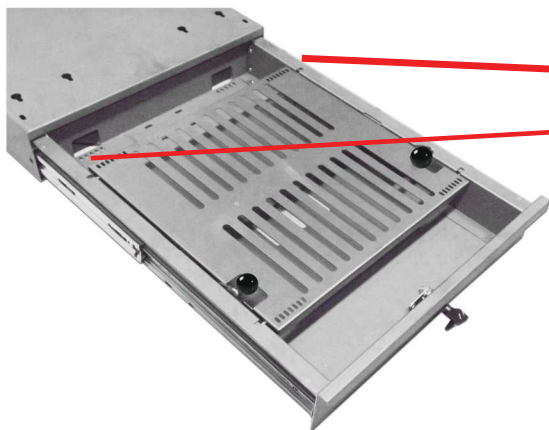





## EDUCATIONAL

### Art. DESKNET5834

Cassetto a scomparsa in metallo per registro elettronico/notebook/tablet, monitor e tastiera, da incorporare su scrivanie o mobili in genere, con ripiano auto sollevante.

*Disappearing drawer in metal for electronic register / notebook / tablet, monitor and keyboard to embed on desks or furniture in general, with shelf raising drive.*



Coperchio in fibra di legno non incluso  
*Top made of wood fibers not included*

Adattatore per monitor con vesa 10x10  
*Vesa 10x10 monitor adapter*

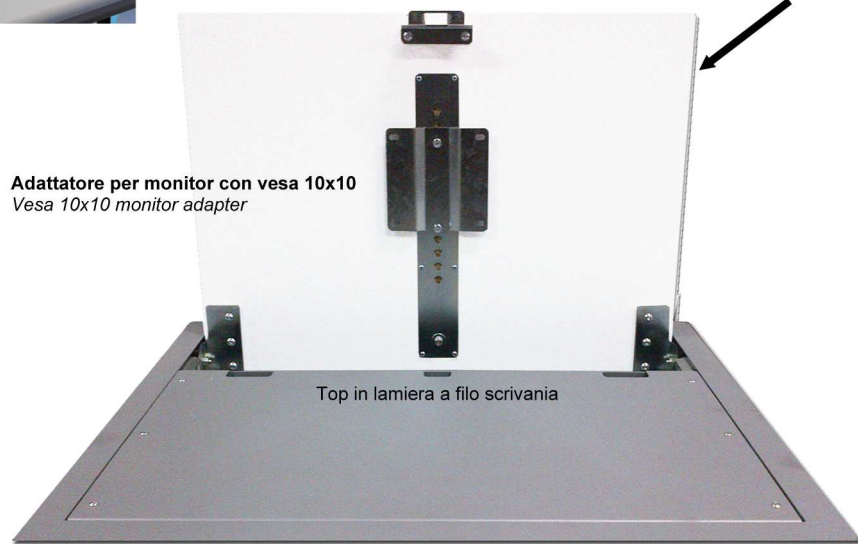

Top in lamiera a filo scrivania

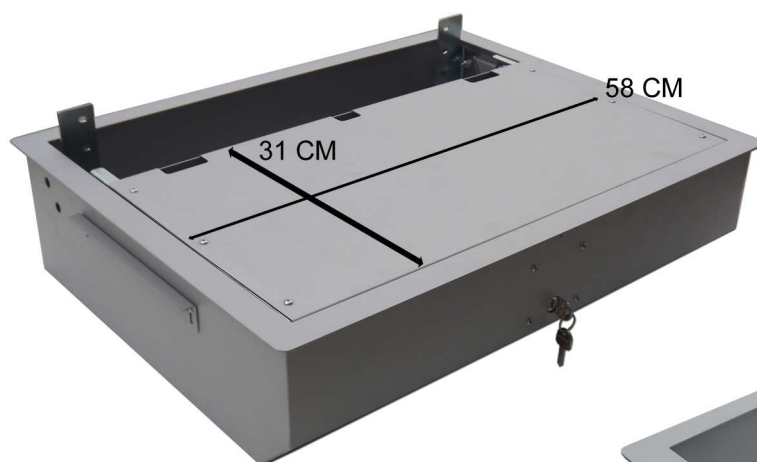

Dotato di serratura a scatto con chiave sotto il piano scrivania e salita del piano a mezzo di 2 pistoncini a gas.

*With special lock with key under desk piano and shelf raising by 2 gas pistons.*



**Art. DESKNET5033EX**

Box in metallo per notebook/tablet utile per gestione registro elettronico o LIM , da fissare su scrivanie o mobili in genere, con ripiano estraibile su guide, chiuso a chiave, dimensioni cassetto interno 50x33 cm, dimensioni esterne 54x35,5x8,5(h) cm.

*Metal box for notebook / tablet useful for managing electronic register or AWB. It can be fixed on desks or furniture in general, with pull-out shelf rails, lockable drawer. Interior dimensions 50x33 cms, outside dimensions 54x35,5x8,5 (h) cms.*

Ripiano interamente estraibile su guide in acciaio. *Shelf entirely removable on steel guides.*



Particolare delle guide con fermo su più posizioni anti-arretramento. *Detail of the guides with stop on multiple locations anti-retraction.*

Particolare dell'interno con evidenza del sistema meccanico per la gestione dei cavi. *Detail of the interior with evidence of the mechanical system for the management of cables.*







## EDUCATIONAL

**Art. TABOX****CARRELLO IN LAMIERA SU RUOTE PER CUSTODIA E CARICA TABLET A 18, 27, 36 POSTI  
METAL HOUSING BANK CHARGER FOR 18,27,36 TABLET PC**Caratteristiche Principali

- Custodisce e ricarica 18, 27,36 tablet pc;
- Scomparti rimovibili singolarmente per accedere facilmente a ciascun computer;
- Dimensione singolo scomparto 290Px27Lx225H mm
- Maniglia girevole con serratura di sicurezza incorporata a 2 o 3 punti di chiusura;
- Periodi di ricarica programmabili (sia la durata che l'orario di ricarica)
- Ricarica contemporaneamente netbook/tablet di diversi marchi e modelli;
- Alimentazione e cavi alloggiati in scompartimenti separati;
- Sistema di alloggiamento studiato per tenere in perfetto ordine cavi e alimentatori;
- Unico cavo di alimentazione per una maggiore sicurezza elettrica;
- Sistema di ventilazione per raffreddare i portatili durante la ricarica (opzionale);
- Maniglie superiori per un agevole spostamento
- Finiture: Bianco, Verde, Nero;
- Ruote gommate anti-vibrazione bloccabili;
- Garanzia europea;
- Marchiatura CE.

**Art. TABOX518**

Altezza: 975 mm  
Profondità: 480 mm  
Larghezza: 560 mm

**Art. TABOX527**

Altezza: 975 mm  
Profondità: 480 mm  
Larghezza: 560 mm

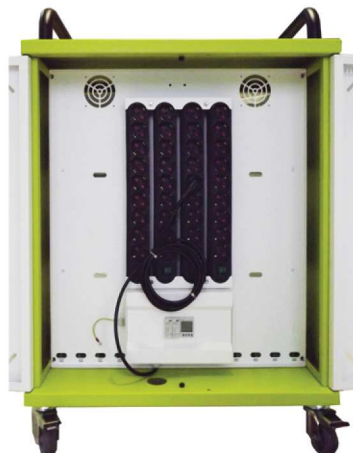
**Art. TABOX536**

Altezza: 975 mm  
Profondità: 480 mm  
Larghezza: 710 mm





## Art. NETBOX

**CARRELLO SU RUOTE PER CUSTODIA E CARICA DI NOTEBOOK**  
LAPTOP HOUSING BANK CHARGER



Ogni ripiano (1 per ogni computer) è facilmente amovibile (per un eventuale utilizzo strategico degli spazi) e presenta un foro di uscita laterale per il connettore di alimentazione con clip di alloggiamento dello stesso. Il vano posteriore è predisposto per l'ancoraggio degli alimentatori e il corretto alloggiamento dei cablaggi. Chiusura anteriore e posteriore (sotto e sopra) con chiave di sicurezza tubolare. Nel vano posteriore sono presenti ciabatte di alimentazione con interruttore controllate da orologio per una agevole programmazione degli orari di carica. Predisposizione per ventole 80x80 con termostato nel vano posteriore. Feritoie per la ventilazione anteriori e posteriori. Maniglioni superiori per un'agevole spinta. Ruote in gomma maggiorate. Ottima manovrabilità. Struttura alleggerita. Realizzato interamente in lamiera di acciaio. Verniciatura con polveri epossidiche gofrata antigraffio.

*Each shelf (1 for each computer) is easily removable (for a possible strategic use of space) and has a side exit hole for the power connector with a clip of the same slot. The rear compartment is designed to anchor the power supply wiring and proper housing. Locking front and rear (below and above) with tubular security key. The rear universal multi-sockets are controlled by power switch clock for easy scheduling of charge. Arrangement for 80x80 fan with a thermostat in the rear. Slits for ventilation, front and rear. Handles for easy pushing on the top. Oversized rubber wheels. Excellent maneuverability. Lightweight structure. Entirely steel made. Embossed scratch-resistant epoxy paint.*

## Art. NETBOX518

**18 ripiani - 18 shelves**

H 99 x L 72 x P 57 cm  
(manici inclusi - included handles)  
Peso / Weight: 63 Kgs

<b>Tech Info:</b>	
1 pz	
0,4234 cbm	
<b>Max Load / Portata:</b>	
130 Kg	

Predisposizione per ventole 8x8x3,8 cm e termostato.  
*Prepared for fans 8x8x3,8 cm and thermostat.*

Ciabatte con prese di alimentazione Italiana bipasso e shucko.  
*Universal multiple sockets.*

Temporizzatori per la corretta gestione dell'alimentazione e per ridurre il carico sulla presa generale.  
*Power switch clocks for easy scheduling of charge and to reduce load on general socket.*

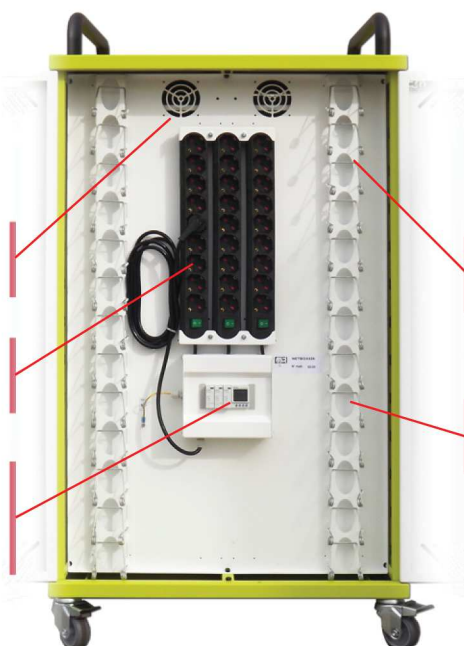

## Art. NETBOX526

**26 ripiani - 26 shelves**

H 130 x L 72 x P 57 cm  
(manici inclusi - included handles)  
Peso / Weight: 84 Kgs

<b>Tech Info:</b>	
1 pz	
0,5547 cbm	
<b>Max Load / Portata:</b>	
130 Kg	

Clip a molla per l'alloggiamento degli alimentatori.  
*Spring clip for the housing of the power supplies.*

Guide per il corretto alloggiamento dei cavi.  
*Guide for proper seating of the cables.*

**Particolari del vano posteriore.**  
*Details of the rear compartment.*



# EDUCATIONAL

01



## Art. SUPPRO4040R

**Supporto mobile in metallo per videoproiettori, telescopico, richiudibile con ripiano aggiuntivo.**

Mobile metal stand for projectors, telescopic, folding with additional shelf.



Completamente richiudibile per un agevole trasporto.  
Telescopico.  
Piano superiore dimensione 40x40 cm inclinabile +20-90° con bordi anticaduta e asole per passaggio di cinghie, cavi, etc.  
Ripiano inferiore riposizionabile e richiudibile dimensioni 30x40 cm.  
4 gambe completamente richiudibili su ruote con freno.  
Peso 11 kg  
Dimensioni imballo 42x25x103

*Fully collapsible for easy transport.  
Telescopic.  
Upper shel ,size 40x40 cm, +20-90 ° tilt and fall edges with holes for passage of belts, cables, etc..  
Bottom shelf repositionable and re-sealable, size 30x40 cm.  
4 folding legs on wheels with brakes.  
Weight 11 kg  
Package dimensions 42x25x103*



## Art. SUPPRO4040S

**Supporto mobile in metallo per videoproiettori, telescopico e richiudibile.**

Mobile metal stand for projectors, telescopic and folding.



Completamente richiudibile per un agevole trasporto.  
Telescopico.  
Piano superiore dimensione 40x40 cm inclinabile +20-90° con bordi anticaduta e asole per passaggio di cinghie, cavi, etc.  
4 gambe completamente richiudibili su ruote con freno.  
Peso 11 kg  
Dimensioni imballo 42x25x103

*Fully collapsible for easy transport.  
Telescopic.  
Upper shel ,size 40x40 cm, +20-90 ° tilt and fall edges with holes for passage of belts, cables, etc..  
4 folding legs on wheels with brakes.  
Weight 11 kg  
Package dimensions 42x25x103*

## SUPPROQ\_CF Series

SUPPORTI UNIVERSALI PER VIDEO PROIETTORI A CORTA FOCALE.  
SHORT THROW UNIVERSAL PROJECTOR MOUNTS



Supporto universale professionale telescopico doppio uso: da parete per videoproiettore a corta focale e da soffitto o pavimento per schermi piatti con vesa 10x10. Micro regolazione dei quattro assi di puntamento +/- 20° mediante 4 manopole, senza utilizzo di attrezzi (brevetto n. 1359423). Micro regolazione dell'angolo della barra portante -3/+20° mediante una singola vite a brugola. Passaggio interno di cavi e connettori. Viteria per videoproiettore inclusa.

*Universal professional telescopic mount for double use: Wall short throw projector mount and ground or ceiling TV mount with vesa 10x10. Fine regulation of the axes, without external tools, for easy mounting +/-20° (Italian patent n° 1359423). Fine adjustment of bracket inclination by single screw -3/+20°. Cables and connectors run through the bracket. Kit of tools and hardware included*

### SUPPROQ\_CF3653W

Lunghezza 36/53 cm da parete a centro V.P.  
Lenght 36/53 cm wall/center of V.P.

### SUPPROQ\_CF5381W

Lunghezza 53/81 cm da parete a centro V.P.  
Lenght 53/81 cm wall/center of V.P.

### SUPPROQ\_CF81136W

Lunghezza 81/136 cm da parete a centro V.P.  
Lenght 81/136 cm wall/center of V.P.

Tech Info:	
	CF3653W 4,25 Kg CF5381W 4,91 Kg CF81136W 5,98 Kg
	CF3653W 45 Kg CF5381W 40 Kg CF81136W 35 Kg
<b>MASTER PACK</b>	1 pz
	CF3653W 0,0169 cbm CF5381W 0,0228 cbm CF81136W 0,0335 cbm

## SUPPROQ\_CF\_F Series

SUPPORTI UNIVERSALI PER VIDEO PROIETTORI A CORTA FOCALE.  
SHORT THROW UNIVERSAL PROJECTOR MOUNTS

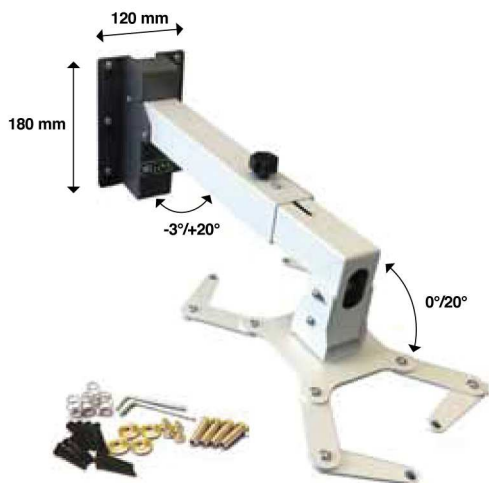

Supporto universale professionale telescopico doppio uso: da parete per videoproiettore a corta focale; e da soffitto o pavimento per schermi piatti con vesa 10x10. Regolazione dell'angolo della barra portante -3/+20° e dell'inclinazione 0/20° del videoproiettore (asse longitudinale). Passaggio interno di cavi e connettori. Viteria per videoproiettore inclusa.

*Universal professional telescopic mount for double use: Wall short throw projector mount and ground or ceiling TV mount with vesa 10x10. Regulation of the longitudinal axis +/-20°. Adjustment of bracket inclination -3/+20°. Cables and connectors run through the bracket. Kit of tools and hardware included*

### SUPPROQ\_CF3653FW

Lunghezza 36/53 cm da parete a centro V.P.  
Lenght 36/53 cm wall/center of V.P.

### SUPPROQ\_CF5381FW

Lunghezza 53/81 cm da parete a centro V.P.  
Lenght 53/81 cm wall/center of V.P.

### SUPPROQ\_CF81136FW

Lunghezza 81/136 cm da parete a centro V.P.  
Lenght 81/136 cm wall/center of V.P.

Tech Info:	
	CF3653FW 3,60 Kg CF5381FW 4,30 Kg CF81136FW 5,50 Kg
	CF3653W 40 Kg CF5381W 35 Kg CF81136W 30 Kg
<b>MASTER PACK</b>	1 pz
	CF3653FW 0,0169 cbm CF5381FW 0,0228 cbm CF81136FW 0,0335 cbm

## SUPPROQ\_CF\_PS3231

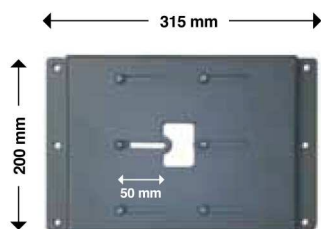

Piastra rinforzo adattatore per SUPPROQ\_CF Series e SUPPROQ\_CF\_F Series utile per fissaggi che necessitano un ancoraggio più largo. Possibilità di movimento orizzontale.

*Reinforcing plate adapter for SUPPROQ\_CF Series and SUPPROQ\_CF\_F Series useful for fixings requiring a larger anchor. Possibility of horizontal movement.*

Tech Info:	
	2,3
<b>MASTER PACK</b>	1 pz
	0,0032 cbm





**MD - Italy**  
Zona Industriale Piane di Sant'Andrea  
64032 Atri (TE) - Italy  
Tel: 0039.085.8780125  
Fax 0039.085.8793077  
E-mail: [info@mditaly.it](mailto:info@mditaly.it)

[www.mditaly.it](http://www.mditaly.it)