



4K UST LASER PROJECTOR User Guide



NORTH AMERICA

E-mail: support@vava.com

Tel: 1-877-969-8282 (Monday-Friday: 9:00 – 17:00 PST)

MANUFACTURER

Manufacturer: Shenzhen NearbyExpress Technology Development Co.,Ltd.

Address: 333 Bulong Road, Shenzhen, China, 518129

Made in China

01-17-2020
VA-LT002_V1.0_EN



SOUND BY
harman/kardon



With the constant optimization of the projector, the User Guide may differ from the actual one.

CONTENTS

PACKAGE CONTENTS	2
PRODUCT DIAGRAM	3
PROJECTOR	3
REMOTE CONTROL	4
QUICK INSTALLATION GUIDE	5
PREPARATION	5
INSTALLING THE PROJECTOR	8
FUNCTIONS	9
1. MOTION DETECTION	9
2. MULTI-SCREEN PROJECTION	9
3. HDR10	9
4. DOLBY AUDIO AND DTS DECODING	10
5. TEMPERATURE PROTECTION	10
OPERATION GUIDE	11
1. POWER ON/OFF	11
2. POSITION ADJUSTMENT	11
3. USER INTERFACE OVERVIEW	12
4. CONNECTION WITH PERIPHERALS	12
5. FILE MANAGEMENT	13
6. SEARCHING FOR / INSTALLING / DELETING APPS	14
7. PAIRING VIA BLUETOOTH	15
8. NETWORK SETTING	16
9. SYSTEM UPGRADE	17
10. IMAGE SETTINGS	17
11. PLAYBACK SETTINGS	19
SPECIFICATIONS	20
CAUTIONS	22
1. ABOUT LASER LIGHT	22
2. HIGH TEMPERATURE	22
3. ROUTINE MAINTENANCE	22
FAQ	23
TROUBLESHOOTING	25
WARRANTY	25
CERTIFICATES	26

PACKAGE CONTENTS

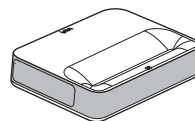

4K UST Laser Projector (Model: VA-LT002)



Remote Control

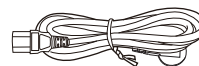

Power Cord



AAA Battery x 2



User Guide



Cleaning Cloth



Please keep the original package properly in case of needed transportation in the future. To protect the product, please wrap it properly as it's received. Only use attachments/accessories specified by the manufacturer.

PRODUCT DIAGRAM

PROJECTOR

Front / Top

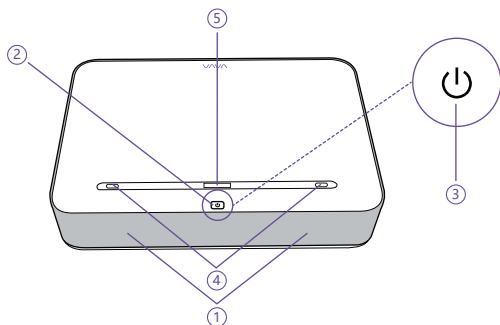

Side

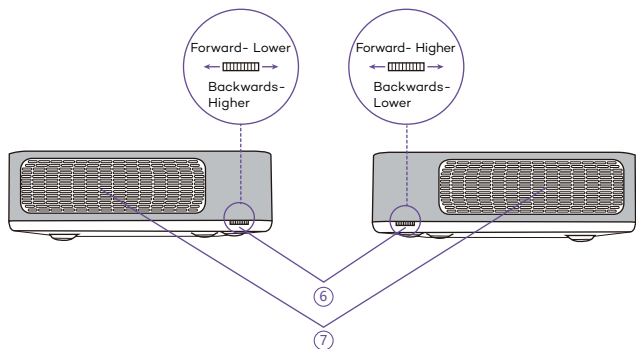

1. Speaker
2. Power Button
3. Status Indicator

- Flashes Projector is starting / shutting off; buttons do not work
- Off Projector disconnects from power / is working normally.
- Solid On Projector connects to power but is not on.

4. PIR Sensor
5. Lens
6. Height Adjusting Wheels
7. Heat Dissipation Vents

Back / Bottom

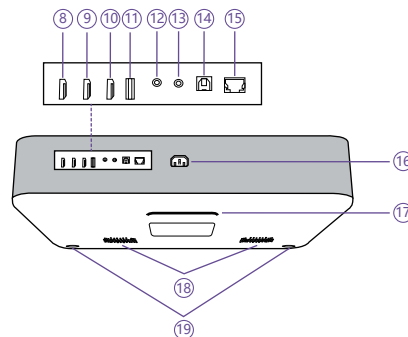

- | | |
|------------------|-----------------------|
| 8. HDMI Input 1 | 14. S/PDIF Port |
| 9. HDMI Input 2 | 15. Ethernet Port |
| 10. HDMI 3 ARC | 16. Power Port |
| 11. USB Port | 17. Rear Foot |
| 12. Audio Output | 18. Speaker Air Vents |
| 13. AV Input | 19. Front Foot x 2 |

REMOTE CONTROL

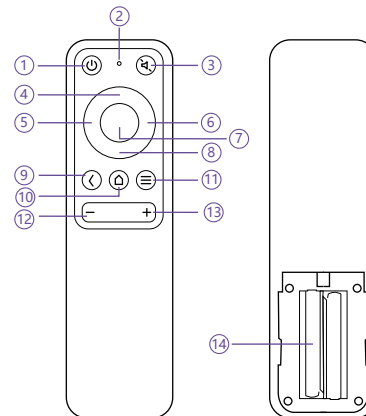

1. Power
2. MIC
3. Mute
4. Up
5. Left
6. Right
7. OK
8. Down
9. Return
10. Home
11. Menu
12. Volume -
13. Volume +
14. AAA Battery Holder



- 1) Press Return and Menu buttons at the same time for Bluetooth pairing.
- 2) During video playing, press Menu button to enter the Menu interface; otherwise, press and hold the button to enter the interface.
- 3) MIC function is not available for now and reserved for future use.
- 4) 2 AAA batteries are required for the Bluetooth remote control.

QUICK INSTALLATION GUIDE

PREPARATION

The socket-outlet shall be installed near the equipment and shall be easily accessible. Take the following 4 items into consideration when installing the projector.

- 1) Distance between the projector back and the wall (W1)
- 2) Heights: image width (height) (H1), height between the bottom of the image and the desk (H2), height of the desk (H3), and the recommended height of the wall (H4)
- 3) Surface for placing the projector

You can place the projector on almost any sturdy, flat and level surface (e.g., a desk).

Dimensions of the desk:

- Mobile desk: W2, H3, and L2
- Immobile desk: W2, H3, L2 and W1 (enough space shall be left to move the device on the desk)

- 4) Image of the projection

The wall for the projection should be larger than the area of your desired image size.

Wall area: length (L3, $\geq L1$) x width (H4, $\geq H1 + H2 + H3$) in the diagram.



Please make sure that the surface for placing the projector and the wall or screen for the projection is flat enough to avoid distorted image.

Parameters for Projection (100" for example)

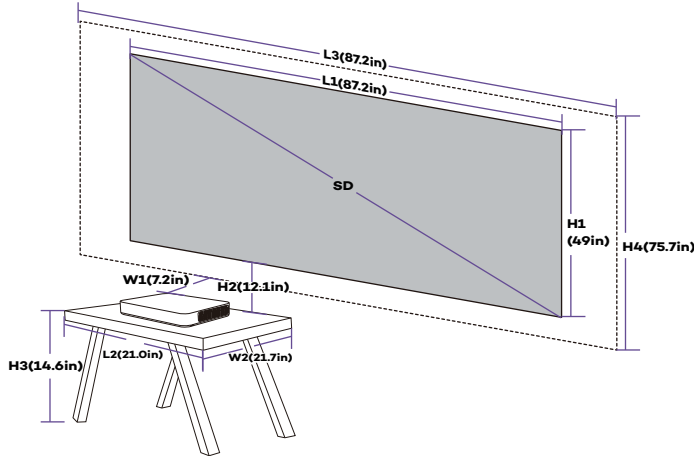

Projection Distance & Image Dimensions

Device Dimensions (LxWxH)	Image SD	Image Length (L1)	Image Width (H1)	Device-Wall Distance (W1)	Image-Desk Height Gap (H2)
53.3 x 36.8 x 10.7cm / 21.0 x 14.5 x 4.2in	80"	177.1cm / 69.7in	99.6cm / 39.2in	8.5cm / 3.3in	26.3cm / 10.4in
	90"	199.3cm / 78.5in	112.1cm / 44.1in	13.4cm / 5.3in	28.6cm / 11.3in
	100"	221.4cm / 87.2in	124.5cm / 49.0in	18.2cm / 7.2in	30.8cm / 12.1in
	120"	265.7cm / 104.6in	149.4cm / 58.8in	27.9cm / 11.0in	35.2cm / 13.9in
	150"	332.1cm / 130.7in	186.8cm / 73.5in	42.4cm / 16.7in	41.9cm / 16.5in

Image SD	Desk Length (L2)	Desk Width (W2)		Desk Height (H3)	Wall Length (L3)	Wall Width (H4)
	L2 \geq L	Mobile Desk: (W2 \geq W)	Immobile Desk: (W2 \geq W+W1)	Image center at 1.3m high	L3 \geq L1	H4 \geq H1+H2+H3
80"	\geq 53.3cm / 21.0in	\geq 36.8cm / 14.5in	\geq 45.3cm / 17.8in	53.9cm / 21.2in	\geq 177.1cm / 69.7in	\geq 179.8cm / 70.8in
90"			\geq 50.2cm / 19.8in	45.4cm / 17.9in	\geq 199.3cm / 78.5in	\geq 186.5cm / 73.4in
100"			\geq 55cm / 21.7in	37.0cm / 14.6in	\geq 221.4cm / 87.2in	\geq 192.3cm / 75.7in
120"			\geq 64.6cm / 25.4in	20.1cm / 7.9in	\geq 265.7cm / 104.6in	\geq 204.7cm / 80.6in
150"			\geq 79.2cm / 31.2in	0cm / 0in	\geq 332.1cm / 130.7in	\geq 228.7cm / 90.0in

Take 100" image (immobile desk) for example.

- 1) Distance (W1): 18.2cm / 7.2in.
- 2) Heights: H1: 124.5cm / 49.0in; H2: 30.8cm / 12.1in; H3: 37.0cm / 14.6in (thus the image center is at 1.3m / 51.2in high, suitable for audience sitting on a sofa in front); H4: \geq 192.3cm / 75.7in.
- 3) Area of the desk (L2 x W2): \geq 53.3 x 55cm / 21.0 x 21.7in.
- 4) Area for the wall (L3 x H4): \geq 221.4 x 192.3 cm / 87.2 x 75.7in.



- 1) Conversion figures may have been rounded up or down.
- 2) Leave plenty of space around and under the projector for ventilation, and keep the vents unblocked in all directions.
- 3) Position the projector within reach of a grounded electrical outlet or extension cord.
- 4) The image size increases as the projector gets farther from the wall. Please move the desk for placing the projector as the distance requires.
- 5) For H3, a recommended value is provided for a better experience since you would feel it comfortable watching from the sofa when the image center is at 1.3m / 51.2in high. You can change it as per actual needs.

INSTALLING THE PROJECTOR

Place the projector on the desk, move to the appropriate distance for the desired image size when keeping the device in parallel with the wall.

Connect the projector to power, press the Power Button on the device or remote to turn it on. Follow the instructions to go through the wizard, including the following operations:

- 1) Pair with remote control
- 2) Choose a language
- 3) Network settings
- 4) Select the installation method



FUNCTIONS

1. MOTION DETECTION

There are two PIR motion sensors at the front of the projector; when it detects human approaching, the projector will lower the brightness of the laser light in case of any harm to our eyes. This function is active by default and can be disabled in the Settings →General. Press any button on the remote control, and the laser light will restore to the normal brightness.

2. MULTI-SCREEN PROJECTION

With the VAVA Projector app, you can project files on your mobile to a flat surface (wall e.g.) to view videos, music, pictures, documents, etc. by the push function. Or, you may mirror your mobile screen to the wall to watch videos, play games, or whatever operations on your mobile by the mirror function.



- 1) Find and install the VAVA Projector app on App Store or Google Play. Currently the Android version supports push and mirror while the iOS only does push.
- 2) When using this function, do make sure your mobile and the projector connect to the same network.
- 3) You may use the app as a remote control – please refer to the app for detailed instructions.

3. HDR10

This projector supports the HDR10, the most widely used High Dynamic Range technology currently, especially for Blu-ray device and professional game console. Different from other devices without the HDR10, the projector provides images with a wider dynamic range and more details. In other words, with this device, you can enjoy no matter of bright and dim images.

4. DOLBY AUDIO AND DTS DECODING

The projector supports Dolby Audio and DTS (dedicated to sound) decoding, perfect for a home theater.



- 1) Manufactured under license from Dolby Laboratories. Dolby, Dolby Audio and the double-D symbol are trademarks of Dolby Laboratories.
- 2) For DTS patents, see <http://patents.dts.com>. Manufactured under license from DTS Licensing Limited. DTS, the Symbol, DTS and the Symbol together, DTS-HD, and the DTS-HD logo are registered trademarks and/or trademarks of DTS, Inc. in the United States and/or other countries. ©DTS, Inc. All Rights Reserved.

5. TEMPERATURE PROTECTION

The built-in temperature protection function can protect the device safe in the occasion of a high ambient temperature. The projector will enter the eco mode automatically and lower the brightness to reduce power thus temperature increase when the ambient temperature is higher than 35°C. If the temperature goes up to 40°C, the device will prompt a warning message; when it reaches 43°C, the device will activate the function of protection against abnormalities and shut off.



The actual temperature threshold will deviate to some extent.

OPERATION GUIDE

1. POWER ON/OFF

Connect the projector to power, press the Power button on the projector or the remote to power it off / on.

2. POSITION ADJUSTMENT

Refer to the following instructions to adjust the position of the projector and get an undistorted image.

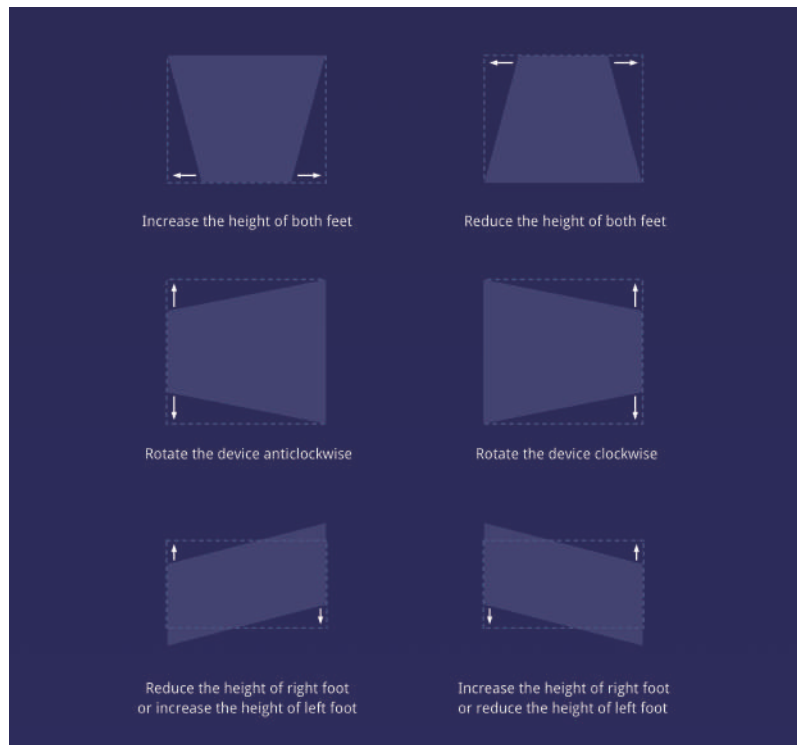

3. USER INTERFACE OVERVIEW

There are mainly 4 sections on the homepage, including the followings: signal source (HDMI & AV), App Store, File Manager, and Multi Screen. On top you can see the Network, Notification, Bluetooth, and Settings icons as well as the time.

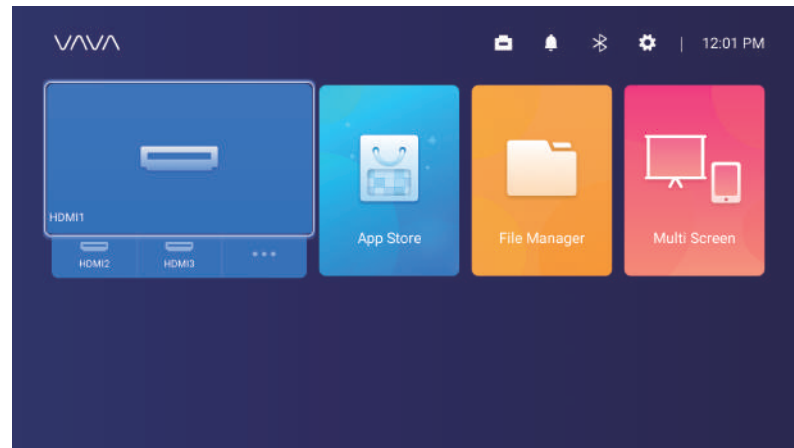

4. CONNECTION WITH PERIPHERALS

You may connect PS4 game console, ROKU TV, computer, etc., via the HDMI port, DVD device by the AV port, USB device by the USB port (refer to 5. File Management), or professional audio by S/PDIF or LINE OUT port.

- 1) Choose the corresponding signal source for the device connected, including HDMI1, HDMI2, HDMI3, and AV. To support 4K 60Hz and HDR10, press and hold the Menu button under HDMI to enable HDMI2.0. To support CEC, press and hold the Menu button under HDMI to enable CEC.



2) Selecting audio output

On the homepage, go through Settings -> Sound, and select the corresponding output method among the following 4 ones in Audio Output .

- Speaker: Use the built-in speaker
 - Headphone: Connect to headphones
 - S/PDIF: Connect to external audio device by S/PDIF port
- PCM: All formats will be converted to PCM for output.
RAW: No processing for the source audio. Recommended for Dolby Audio and DTS sources for better performance.
- HDMI ARC: Output the sound via the HDMI ARC port

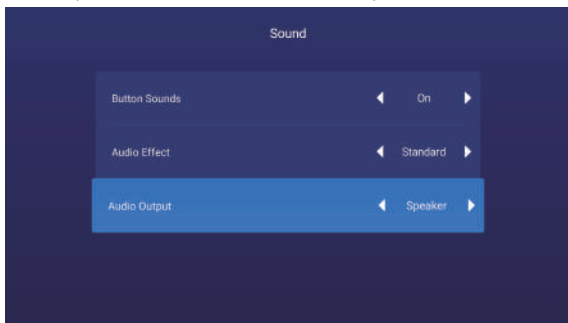

5. FILE MANAGEMENT

On File Manager, you can manage the files in the internal flash, USB drive plugged, and on the NetHood.

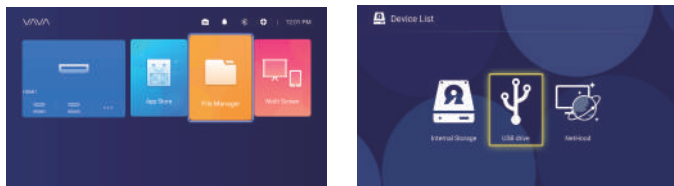

1) Internal Flash

You can save files to the projector storage, including the apps downloaded, files downloaded in the app, files in the USB drive, etc.

2) Using the USB drive

Plug in the USB Drive and you may view the files on the interface.

3) NetHood

You can view files shared by other devices on the same network by NetHood.



Support saving, viewing, copying, and deleting files through the All Files folder under these circumstances.

6. SEARCHING FOR / INSTALLING / DELETING APPS

The device comes equipped with the Android 7.1 system and the application store and supports downloading and installation of more than 600 apps in videos, music, games, etc., as you want. You may just enter the App Store on the homepage and search for, download, and install the app.

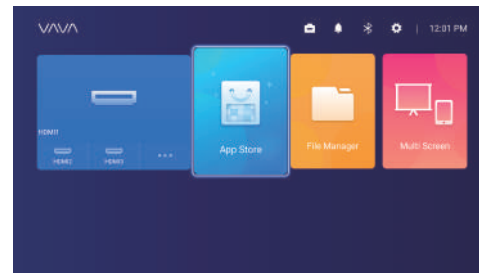

To delete an app, you can just select the app on the homepage, press and hold the OK button, select OK on the pop-up window.



Press the Home button twice to call out the app background.

7. PAIRING VIA BLUETOOTH

Select the Bluetooth icon at the top right corner to enter the Bluetooth interface.

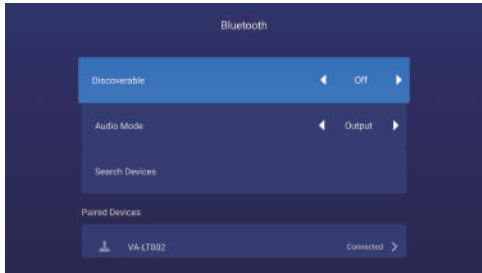

1) Use as Bluetooth speaker

Turn on the Open Detection, select Input for Audio Mode on the interface, find and tap the projector model under Bluetooth Devices on your phone or laptop to play audios on your device via the built-in speaker of the projector. (Go to Settings -> General -> Device Name to check the Bluetooth name of the projector)

2) Pairing with audio devices

Select Output for Audio Mode on the interface, select Search Devices, find and select your audio device under Searched Devices, and the pairing will start automatically. The paired Bluetooth device will appear under Paired Devices.

3) Pairing with other devices

To pair with Bluetooth controller, keyboard, mouse, remote, etc., just select Search Devices, and then the device under Searched Devices to pair.



To disconnect with a device, select it in the Paired Devices list and choose neglecting it.

8. NETWORK SETTING

Select the Network icon at the top right corner to enter the network setting interface. For wired connection, just plug in the Ethernet cable. For the wireless, find the network name on the drop-down list, select, and type in the password to connect. It supports network anomaly detection.



1) The Show Password option cannot be selected when the keyboard is shown. You need to press the Return button to exit the keyboard to tick the box.

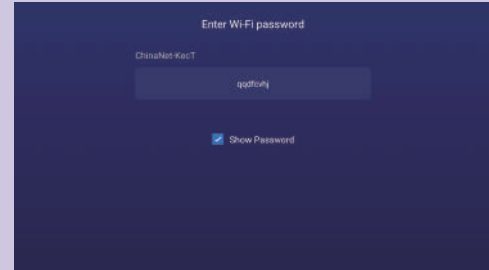

2) After entering the password, select the Done key to connect.

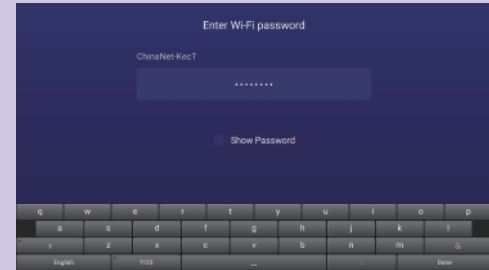

9. SYSTEM UPGRADE

1) OTA (on the air) update

Select Settings -> General -> System Version, select Version Update if any prompt.

2) Upgrade by USB drive

Select Settings -> General -> USB Disk Upgrade, go to Select, and find and choose the upgrade file on the USB drive, and then select Update.

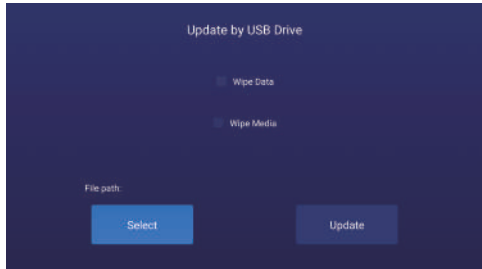

Select the Wipe Data (system-related settings) or / and Wipe Media (files like audio, video, and app) to clear the data or / and media files on the device if needed.

10. IMAGE SETTINGS

Go through Settings -> Display, or press and hold the Menu button when not playing anything to enter the interface.

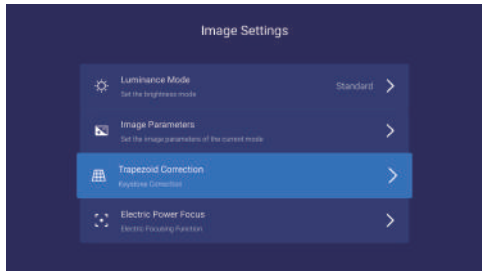

1) Brightness mode

Standard – for standard brightness;

High – for use in a very bright environment.

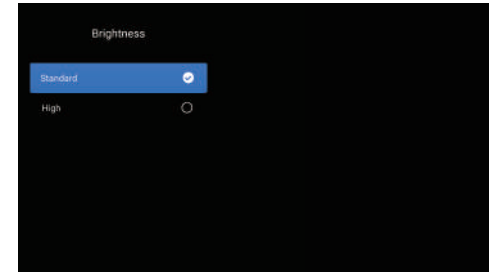

2) Image parameters

You may select the image mode, or self-define the brightness, contrast, saturation, resolution, tone, color temperature, etc.

3) Keystone correction

Besides adjusting the physical position of the device to improve the distortion (refer to 2. Position Adjustment), you may enter the Keystone Correction interface to improve it technically.

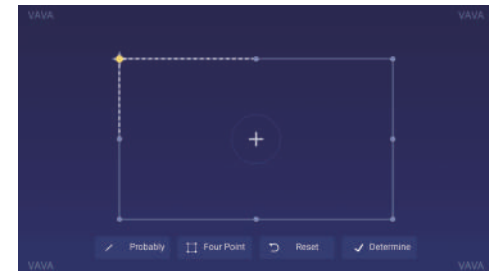

The physical adjustment method described previously in Position Adjustment is preferred since the keystone correction function here is changing the actual image by software bit by bit, which may sacrifice the clarity as a result.

4) Electric focus

Adjust the focus by the Left / Right button on the remote to get the clearest image on the interface.

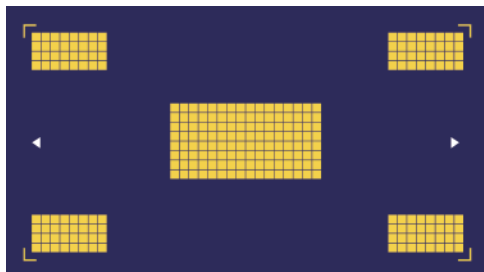

11. PLAYBACK SETTINGS

When playing videos, press the Menu button to prompt a sidebar menu, including the followings: Video ratio, Sound track, Subtitle, Playback settings, Cycle mode, and Audio Effect.

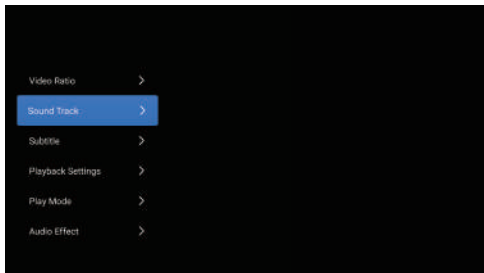

SPECIFICATIONS

Projection System	
Display Type	DLP
Light Source	Laser (ALPD3.0)
Throw Rate	0.233
Projection Size	Up to 150"
Resolution	4K
Brightness	2500 lumen (100% CLO) / 6000 lumen (Light Source)
Luminance Uniformity	> 88%
Contrast Ratio	> 300:1 (ANSI) / > 3000:1 (FOFO)
Color Gamut	Rec.709
Smart TV System	
System	Android 7.1
App Store	Aptoide
EMMC	32GB
Ram	2GB
Motion Detection	Yes
HDR10	Yes
Keystone Correction	Yes(8 points)
Electric Focus	Yes
Multiscreen	Yes
Audio	
Speaker	Harman / Kardon, 60W (total)
Bluetooth In	Yes (Connect with mobile phone)

Bluetooth Out	Yes (Connect with Bluetooth speaker)
DTS	Yes
Dolby Audio	Yes
Interfaces	
HDMI	3 ports (HDCP2.2, 1 with ARC)
USB	1 (5V DC, 500mA)
Video In	AV3.5
Audio Out	Line out 1 (3.5mm) and S/PDIF 1
RJ45	1
Connectivity	
Internet	Wired and wireless (802.11ac 2.4G / 5G 2T2R, with DFS)
Bluetooth	BT4.2 (dual mode)
Power	
Input	100-240V AC, 50/60Hz, 4A
Power Consumption	<360W
Standby Power Consumption	<0.5W
Others	
Dimensions	533 x 368 x 107mm / 21.0 x 14.5 x 4.2in
Weight	10.8kg / 381oz
Noise	<32dB
Working Temperature	0 - 40°C / 32 - 104°F
Storage Temperature	-20 - 65°C / -4 - 149°F
Accessory	
Remote	Bluetooth
Power Cord	1.5m
AAA Battery	2

CAUTIONS

1. ABOUT LASER LIGHT

- Never look into the projector lens when the laser is turned on; the bright light can damage your eyes.
- Do not try to dismantle or modify the projector. It contains a high-power laser component and serious injury could result.
- Do not allow small children to operate the projector. They must be accompanied by an adult for use.

2. HIGH TEMPERATURE

- Do not place anything that can become warped or damaged by heat near the vents.
- Do not bring your hands or face close to the vents while projection is in progress.
- Do not place flammable materials such as aerosols near the device in case of fire.

3. ROUTINE MAINTENANCE

- Please wipe clean the shell and top cover of the projector routinely with the cleaning cloth equipped or others for professional use. Do not apply abrasive detergent, solvent or other coarse chemicals to avoid scrapes. Before cleaning, unplug the power cord from the socket.
- Leave plenty of space around the vents for heat dissipation.
- Do not place anything blocking the speaker for better sound.
- Dismantling the device will not only fail the warranty but may also cause harm to your or others' safety.
- Do not use the projector near water, sources of heat, high-voltage electrical wires, or sources of magnetic fields.
- If you use the projector in a country other than where you purchased it, use the correct power cord for that country.
- Do not block the lens during projection using a book or any other object. This could damage the projector or cause a fire.
- Remove the battery from the remote control for long idle time in case of leakage and damage to the remote.
- Please follow local regulations to promptly and properly dispose of used batteries.

FAQ

Question	Answer
Benefits of laser light source?	For its beautiful color, high brightness, and long life.
The principle of the ALPD technology?	Advanced laser-powered phosphor display (ALPD) is a large-format display technology and the critical technology for laser display. With laser and luminescent material made of rare earth, it can provide a high color gamut for laser TVs, up to 90% of that for human eyes, which is far higher than the 62% of the LED products performing the best in this aspect on the market currently. The most updated laser source technology ALPD3.0 improves the efficiency by the optical design and the reliability by the structure design and material development. The light source has a super long life span of 20,000 hours, and has been used accumulatively for 100,000 hours.
Throw ratio and ultra-short throw?	Throw ratio is the ratio of the distance from the lens to the screen to the screen width. The smaller the ratio is, the larger screen it can be with a same distance. For example, for a 100" SD image, a ratio of 0.233 needs a distance of 516mm between the lens and the screen, when a 1.00 ratio needs 2215mm. A projector with a throw ratio lower than 0.3 can be regarded as an ultra-short throw one.
Need to prepare a screen?	A screen is not a must. The projector can be used for any flat surface. For better performance, please apply to a flat wall with only one color, and a white wall is preferred. Also, using a recommended screen can provide the best experience.
Motion detection not working?	Make sure the sensor is not blocked and the function is active in settings.

Remote control not working?	1) Make sure the remote is loaded with batteries energized; 2) Press the Return and Menu buttons to re-pair; 3) Connect the mouse or keyboard to the USB port, and enter setting. Check if the remote control is connected. If not, connect it again.
Cannot play files in the USB drive?	1) It may be of invalid format that the projector does not support. 2) Backup the files to your computer, format the USB drive, transfer the files back to the drive, and plug the drive into the projector to play again.
No signal after connecting a device by the HDMI port?	There are 3 HDMI ports on the projector. Please make sure you connected to the correct one, the HDMI wire is good, and the HDMI device is power on.
No sounds?	Check whether the correct audio output (built-in speaker / external speaker) is selected for audio setting, and whether it's muted.
Not clear image?	1) Make sure the video is high definition originally. 2) Check if the projector is in focus: go to Settings -> Display -> Electric Focus to adjust the focus.
Keystone correction function?	Supports improving the image distortion problem by software; but the function can only work to some degree and will impact the clarity of the image. Therefore, you're recommended to eliminate or reduce the distortion by physical means.
How to choose the audio output?	When connecting to a speaker, in the settings you can see two output options: PCM and RAW. 1) For PCM output, the audio source is decoded. It features wide compatibility, meaning working with almost all types of speakers; but the sound quality would be compromised. 2) For RAW output, no decoding is involved for the audio output, thus retaining the original sound (as long as the speaker connected supports the decoding of the audio). Generally RAW output is the optimal choice.

TROUBLESHOOTING

Problem	Solution
The device cannot show image or there's an anomaly.	Power off the device, unplug the power cord. Plug it again after 1min and power on the device.
Android system just broke down.	Power off the device, unplug the power cord. Plug it again after 1min and power on the device.
Remote control got disconnected; or cannot power on the device wireless because it's not paired.	Power off the device, unplug the power cord. Plug it again after 1min and power on the device with the button on the device. Then press the Return and Menu buttons at the same time to pair the remote again.
The system prompts a message of high temperature and the device shuts off automatically.	Make sure the device is working in a proper ambient temperature (within the device's working temperature range) and that the vents are not blocked. Restart the device.
The device cannot be powered on.	Check whether the device is connected to power properly and that the socket connects to electricity. Press the Power button on the device to start.
Android system is stuck.	<ol style="list-style-type: none"> 1) Too many system cache: please free up space on Android and delete rarely used apps. 2) Network problem: check whether your network supports watching video online; theoretically, a bandwidth of 8M or higher can provide 1080p videos without getting stuck. 3) Power off the device, unplug the power cord. Plug it again after 1min and power on the device.

WARRANTY

We will provide you with after-sales service based on specific local policies. Please contact your local sales representative or after-sales team for more details. You can email to support@vava.com if you have any questions.

CERTIFICATES

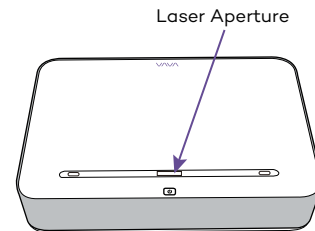
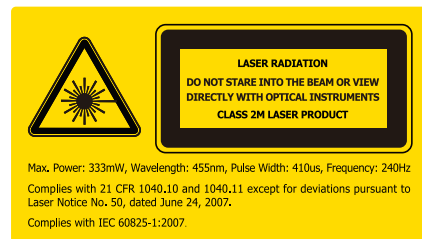

For the customers in the U.S.A.

This projector is a Class 2M laser product that complies with the FDA performance standards in 21 CFR 1040.10 and 1040.11.

Warning:

**LASER RADIATION
DO NOT STARE INTO THE BEAM OR VIEW
DIRECTLY WITH OPTICAL INSTRUMENTS
CLASS 2M LASER PRODUCT**

This device contains licence-exempt transmitter(s)/receiver(s) that comply with Innovation, Science and Economic Development Canada's licence-exempt RSS(s). Operation is subject to the following two conditions:

- (1) This device may not cause interference.
- (2) This device must accept any interference, including interference that may cause undesired operation of the device.

Radio Frequency Exposure Statement for IC

The device has been evaluated to meet general RF exposure requirements. The device can be used in mobile exposure conditions. The min separation distance is 20cm.

Operation of this device is restricted to indoor use only.

FCC Compliance Statement

This device complies with part 15 of the FCC Rules. Operation is subject to the following two conditions:

(1) This device may not cause harmful interference, and (2) this device must accept any interference received, including interference that may cause undesired operation.

Note: This equipment has been tested and found to comply with the limits for a Class B digital device, pursuant to part 15 of the FCC rules.

These limits are designed to provide reasonable protection against harmful interference in a residential installation.

This equipment generates, uses and can radiate radio frequency energy and, if not installed and used in accordance with the instructions, may cause harmful interference to radio communications. However, there is no guarantee that interference will not occur in a particular installation. If this equipment does cause harmful interference to radio or television reception, which can be determined by turning the equipment off and on, the user is encouraged to try to correct the interference by one or more of the following measures:

- Reorient or relocate the receiving antenna.
- Increase the separation between the equipment and receiver.
- Connect the equipment into an outlet on a circuit different from that to which the receiver is connected.
- Consult the dealer or an experienced radio/TV technician for help.

Important: You are cautioned that changes or modifications not expressly approved by the party responsible for compliance could void the user's authority to operate the equipment.

FCC Radiation Exposure Statement:

The radiated output power of this device meets the limits of FCC/IC radio frequency exposure limits. This device should be operated with a minimum separation distance of 20cm (8 inches) between the equipment and a person's body.



The Bluetooth® word mark and logos are registered trademarks owned by the Bluetooth SIG, Inc. and any use of such marks by Sunvalleytek International Inc. is under license. Other trademarks and trade names are those of their respective owners.



Manufactured under license from Dolby Laboratories. Dolby, Dolby Audio and the double-D symbol are trademarks of Dolby Laboratories.



For DTS patents, see <http://patents.dts.com>. Manufactured under license from DTS Licensing Limited. DTS, the Symbol, DTS and the Symbol together, DTS-HD, and the DTS-HD logo are registered trademarks and/or trademarks of DTS, Inc. in the United States and/or other countries. ©DTS, Inc. All Rights Reserved.



The terms HDMI, HDMI High-Definition Multimedia Interface, and the HDMI Logo are trademarks or registered trademarks of HDMI Licensing Administrator, Inc.

Remote Control (Model: VA-LT003) MIC: 204-920001
Projector (Model: VA-LT002) MIC: 204-920002
FCC ID: 2AFDGA-LT002
Compliance with UL 60950-1:2007 R10.14 & CAN/CSA-C22.2 No.0950-1-07+A1:2011+A2:2014



Cancer and Reproductive Harm - www.P65Warnings.ca.gov



IC: 23718-VALT002 HVIN: VA-LT002
IC: 23718-VALT003 HVIN: VA-LT003

尺寸：120*148mm

骑马订

材质：封面封底128克铜版纸（哑粉+覆膜）